

DOUBLE/FRENCH DOOR INSTALLATION GUIDE



Five Star Installation Guide

Frame handing



Follow the same instructions for both inward and outward opening doors.

Identify which is the main sash and which is the secondary sash.

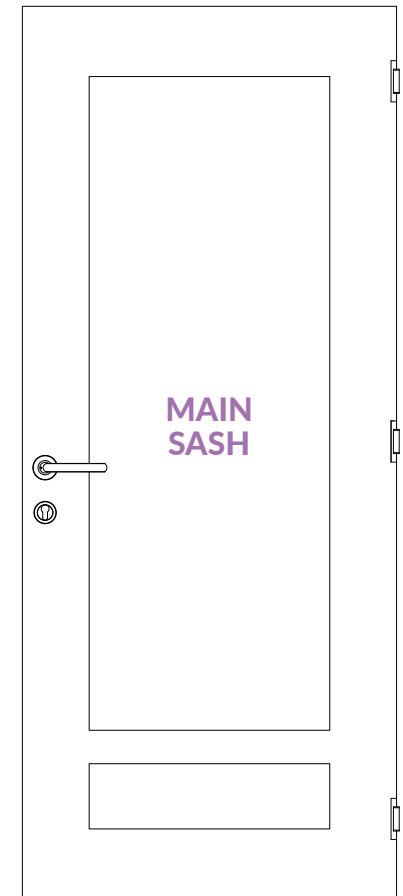
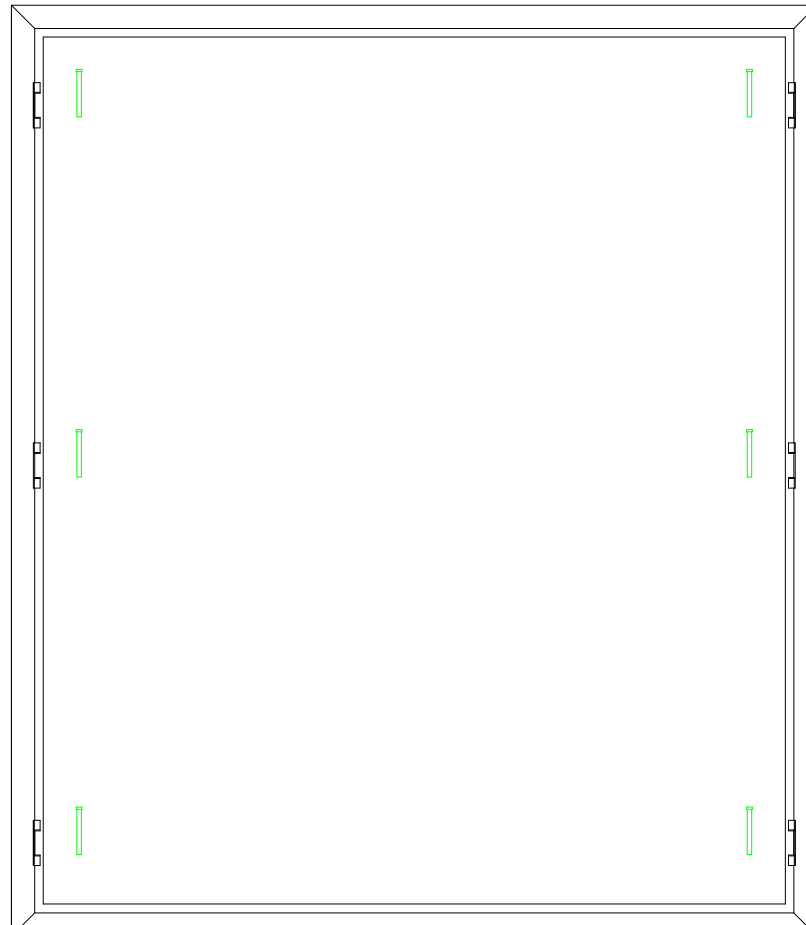
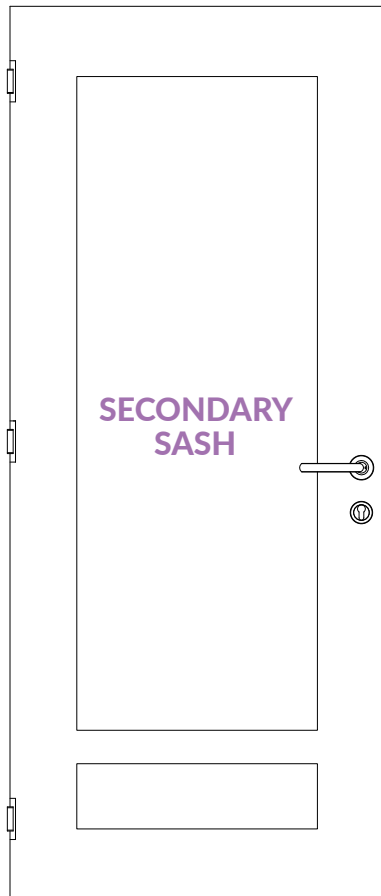

Hang the secondary sash first

INSIDE VIEW

Weather proof the cill

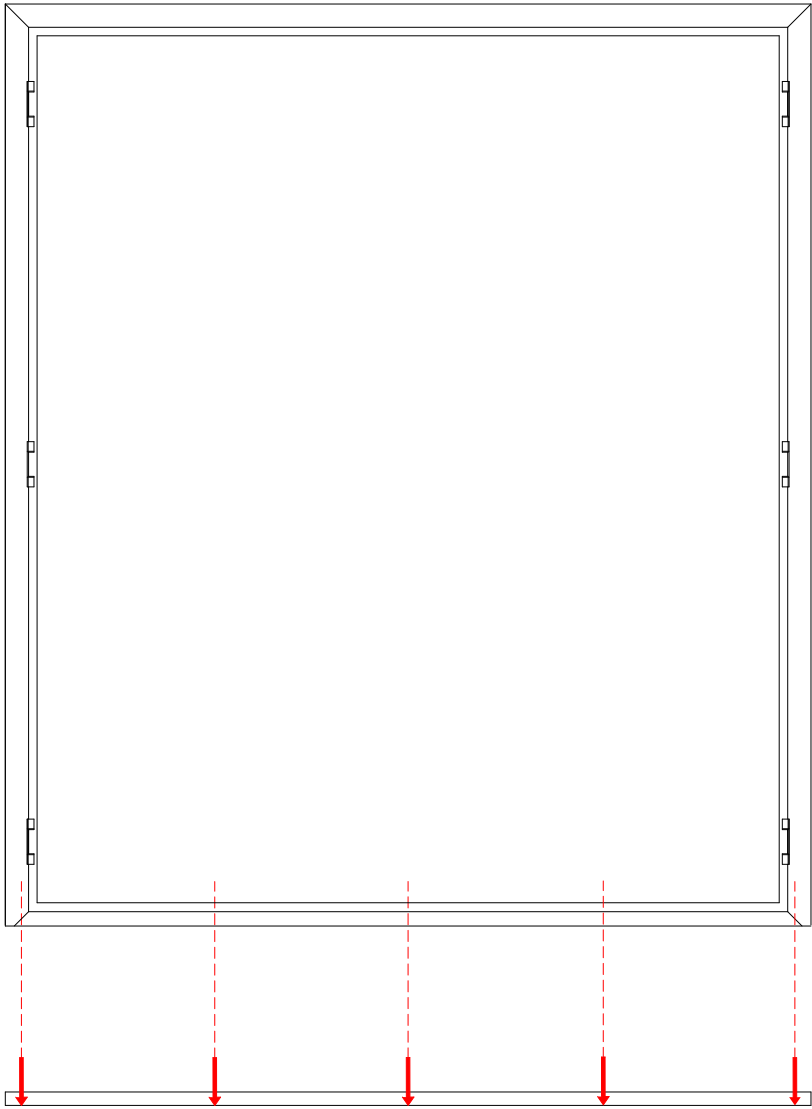

Pilot holes

If a cill is required a reinforced cill must be used for all double/French door installations.

Drill pilot holes through the cill.

Use clear silicone and apply a bead of silicone 10mm from the edge of the cill.

Create a ladder effect as indicated in the diagram below.

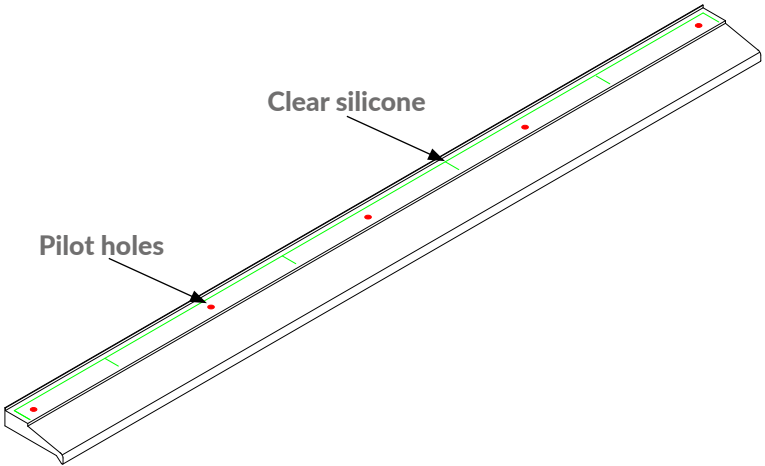

Clear silicone

Pilot holes

Secure the cill



If a cill is required a reinforced cill must be used for all double/French door installations.

Use 50mm bay pole fixings to attach through the cill into the main frame in the positions shown on the diagram.

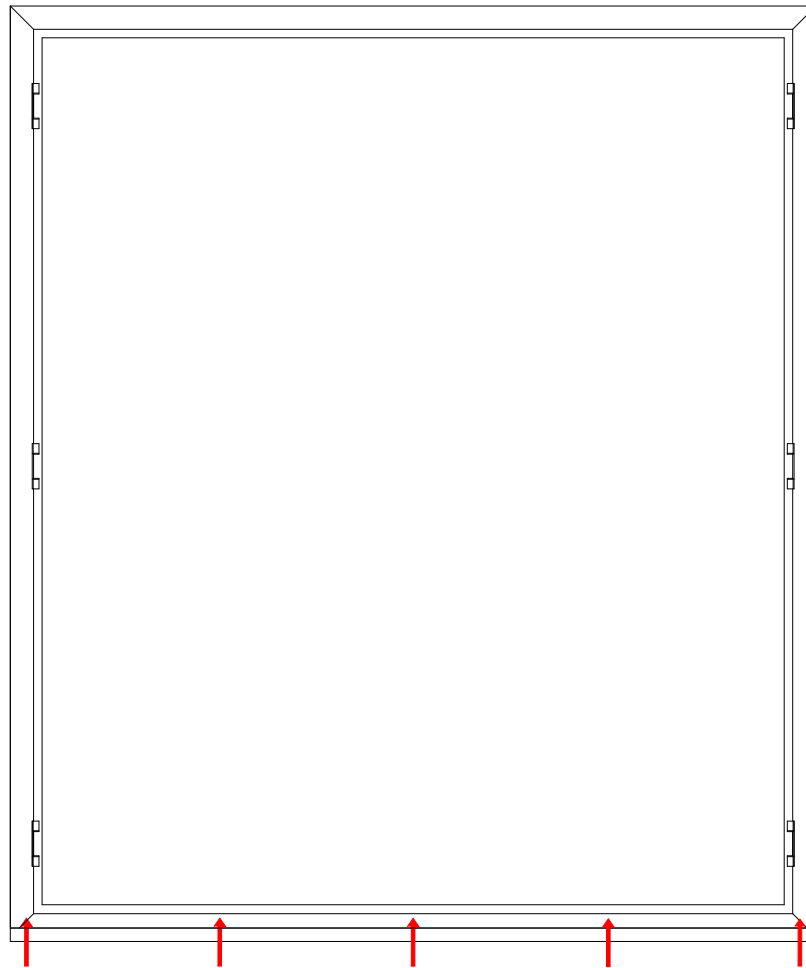

50mm Bay Pole Fixings

INSIDE VIEW

Check to fit



Check the frame will fit in to the opening.

Carefully remove the old frame.

Clean the brickwork ready for the new frame.

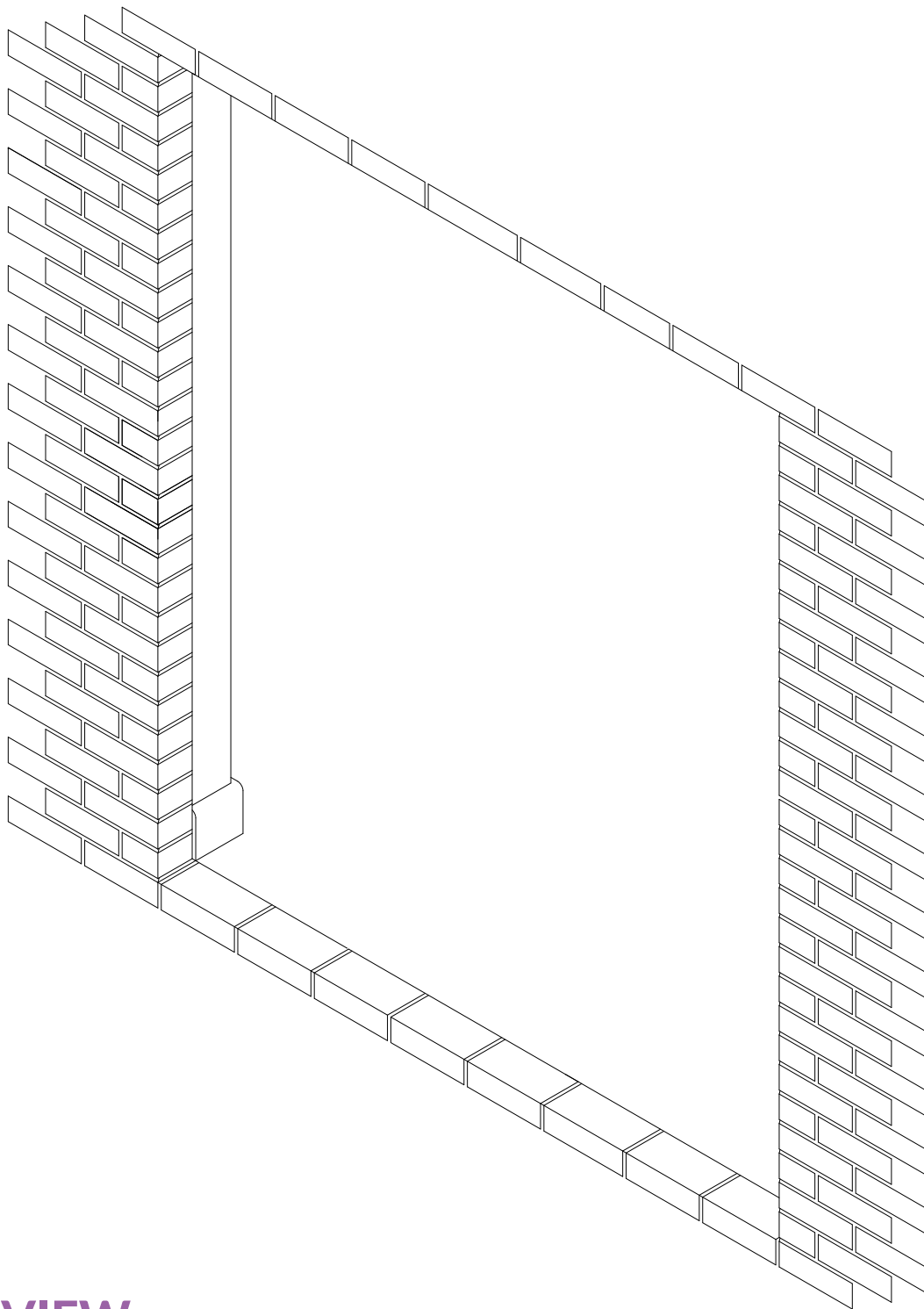

OUTSIDE VIEW

Pack under the secondary door side of the frame

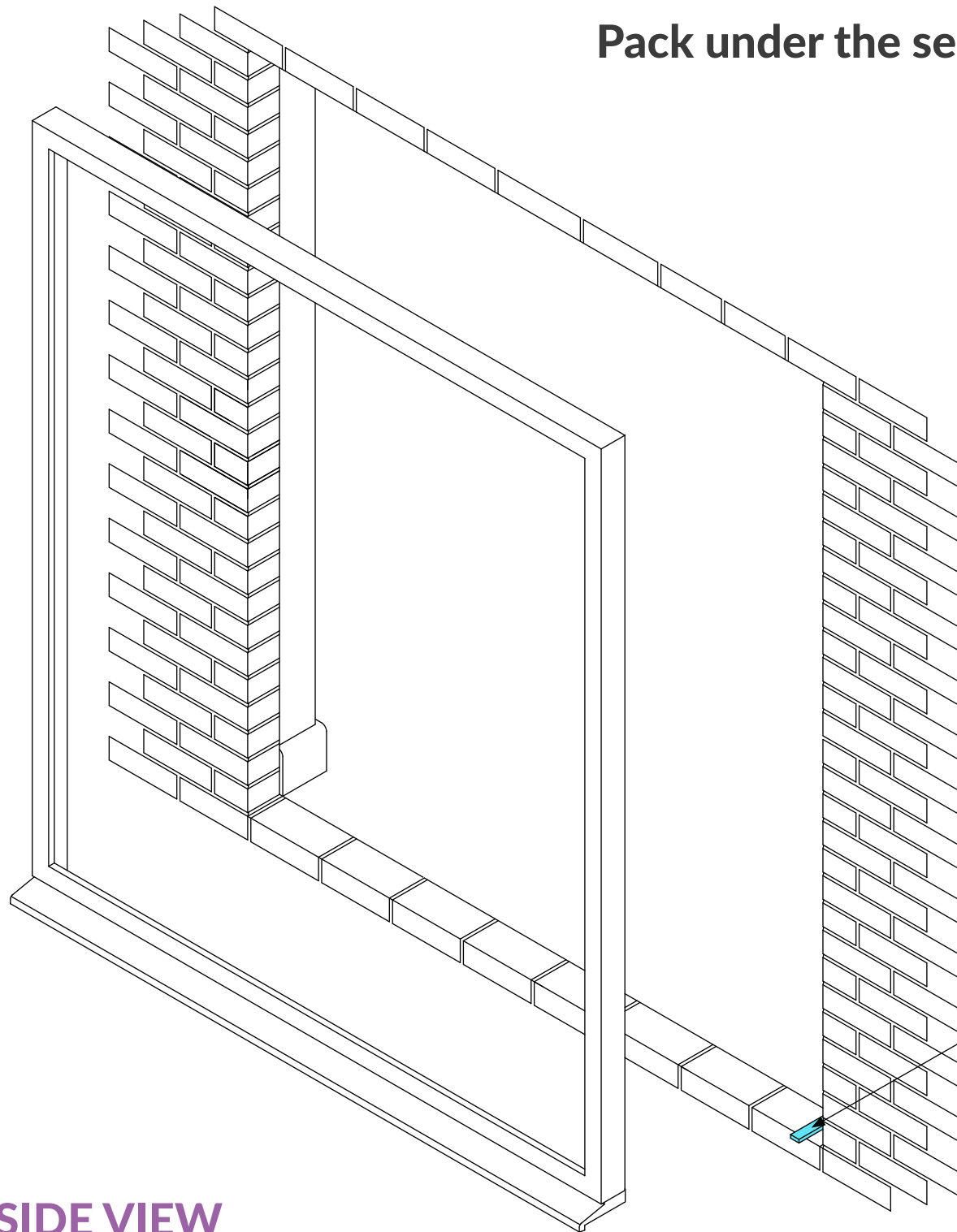

Place a 5mm packer on the base in line with the leg on the secondary door side of the frame.

Offer the assembled frame carefully into the aperture.

OUTSIDE VIEW

Holding the frame in position with winbags

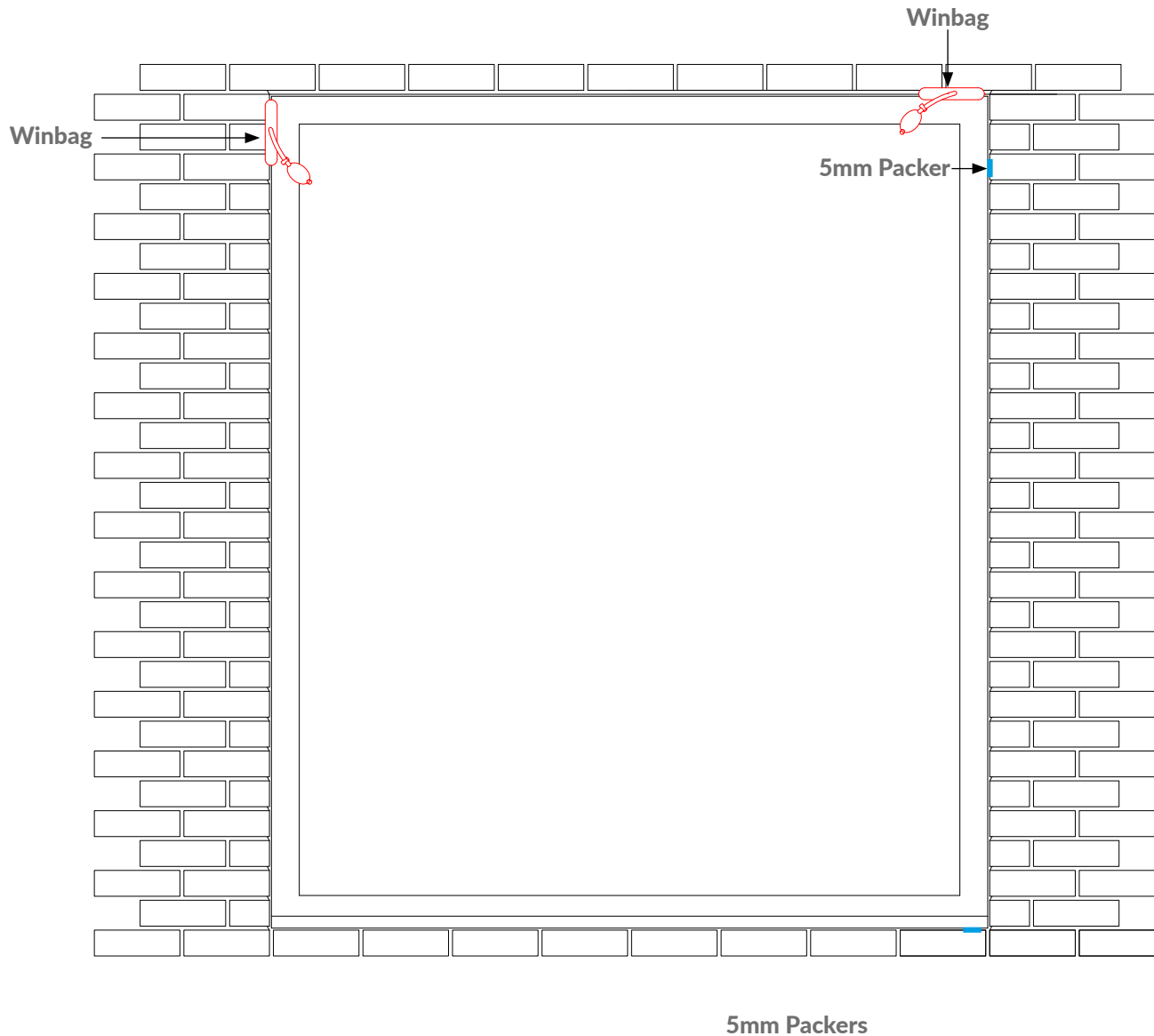

Place a winbag directly over the secondary door hinge side leg of the frame in line with the packer and inflate to hold the frame in position.

In line with a full brick above the top hinge insert a 5mm packer between the frame and the brickwork.

On the opposite side of the frame inflate a winbag to tighten the frame, trapping the 5mm packer in place.

Check the hinge side for plumb



With a spirit level check both the front face and the rebate face of the frame on the secondary hinge side of the frame for plumb and pack as necessary.

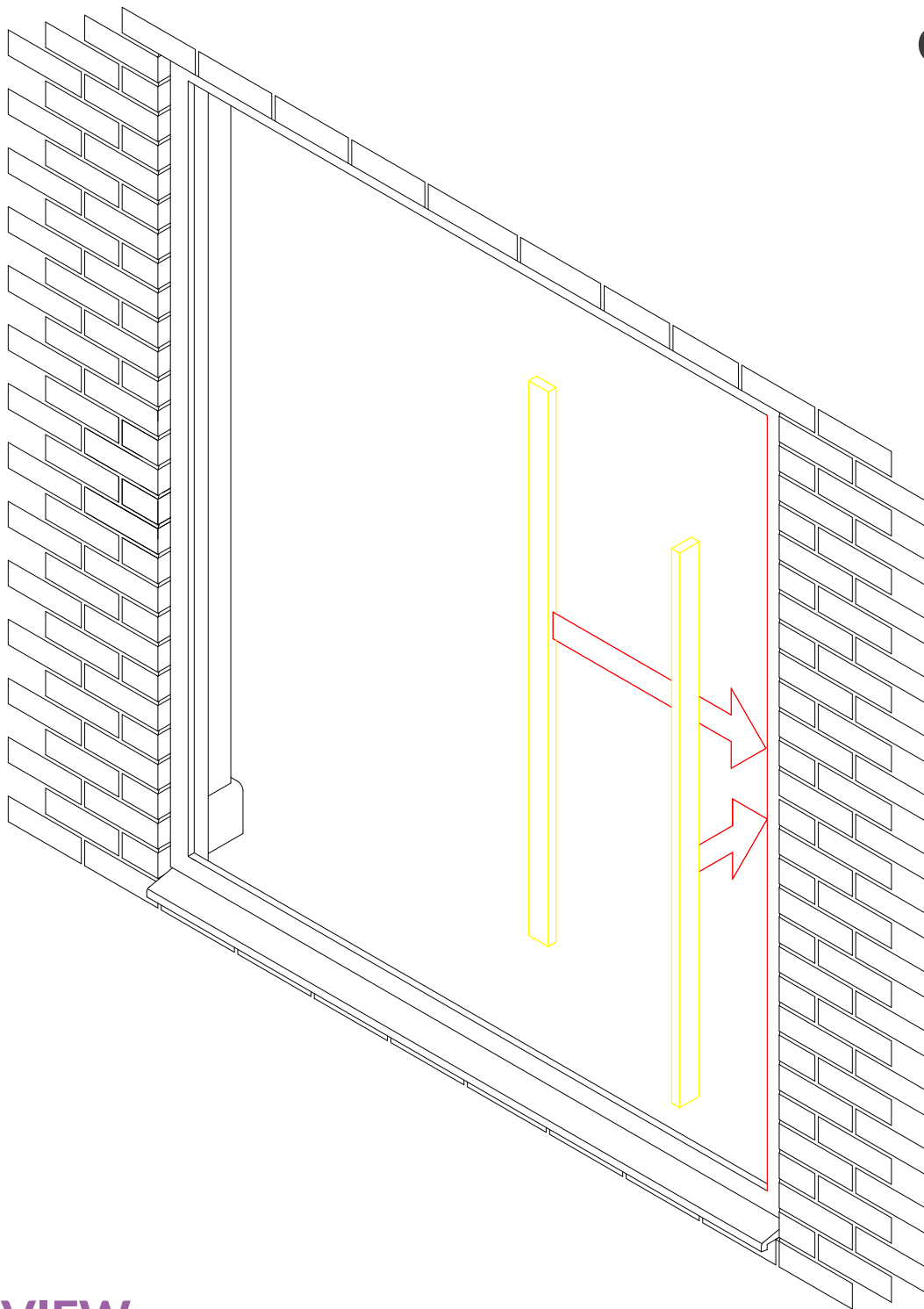

OUTSIDE VIEW

Rehang the Secondary sash into the frame

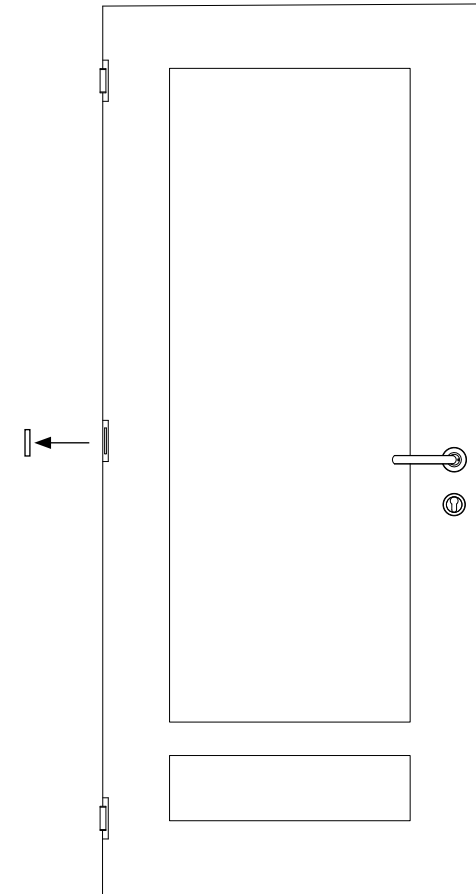
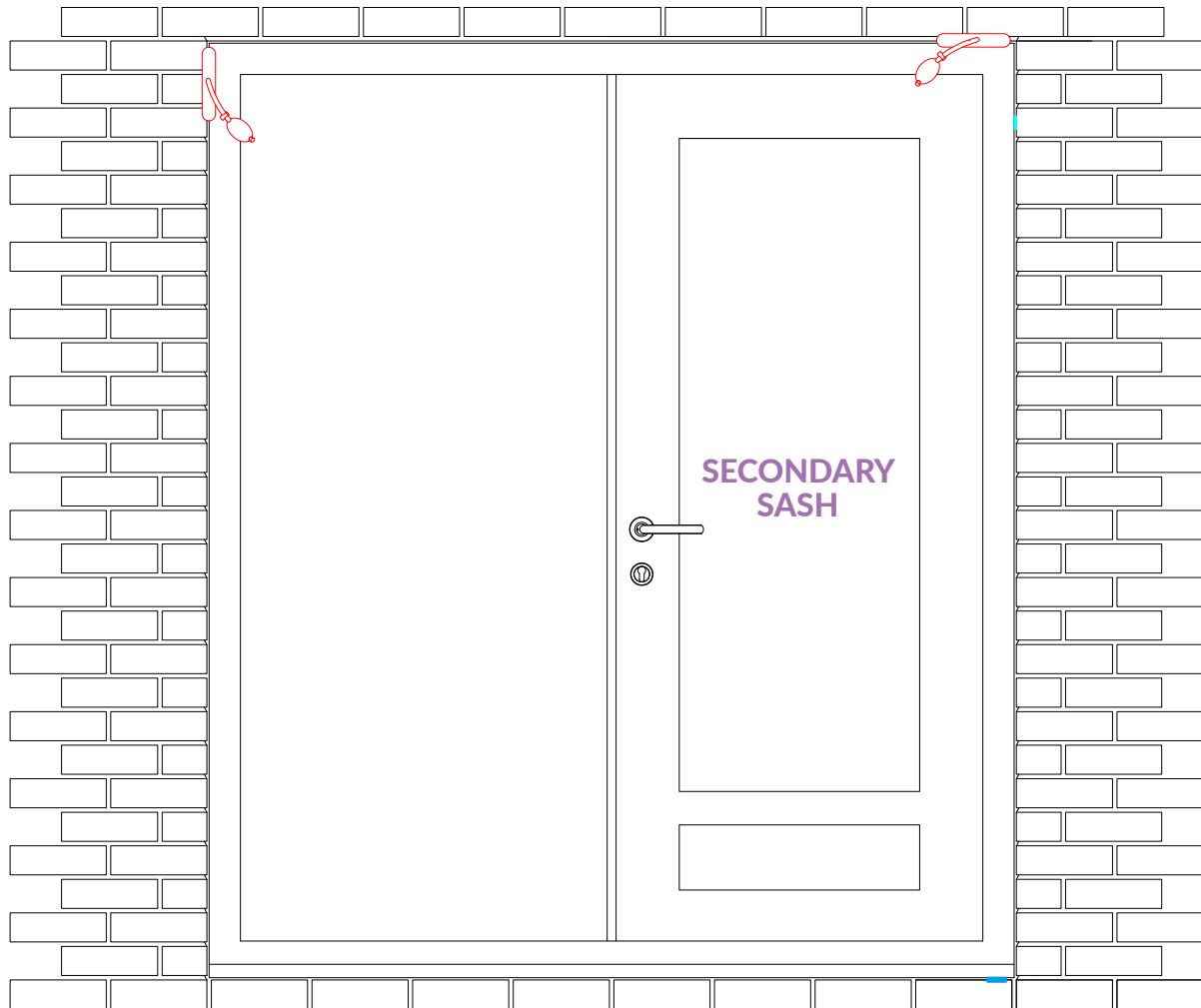

It makes it easier to align if you remove the centre plate of the hinge using a 4mm allen key.
Once the sash is in place, insert the top and the bottom pins. Then refit the plate and then insert the middle pin.

OUTSIDE VIEW

Check the side gap



The side gap MUST be parallel.

Check that the head gap inside is parallel, if it is not, repack with a different thickness packer until the head gap is parallel.

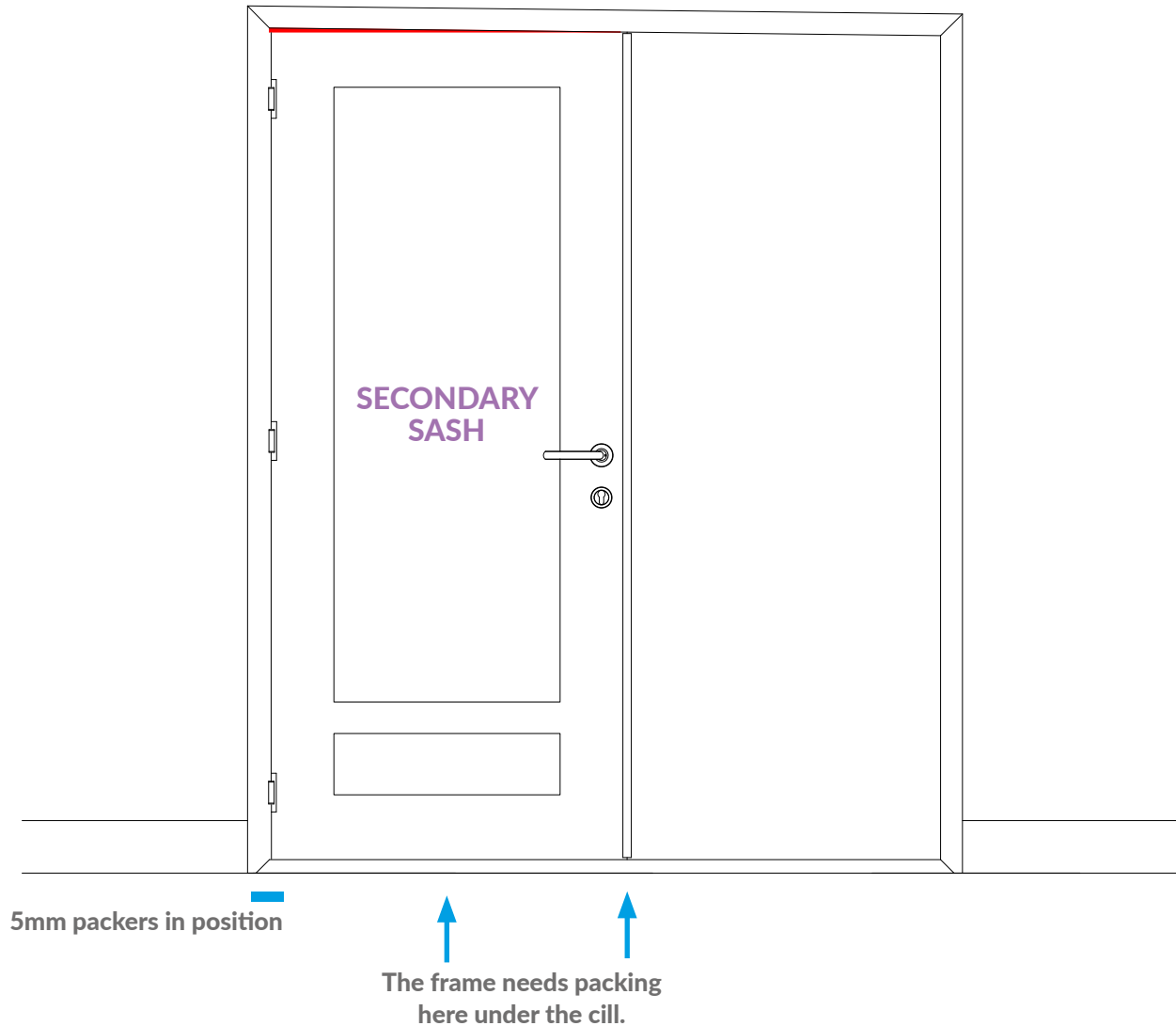

INSIDE VIEW

The head gap and side gap must be parallel before you continue



HEAD GAP MUST BE PARALLEL

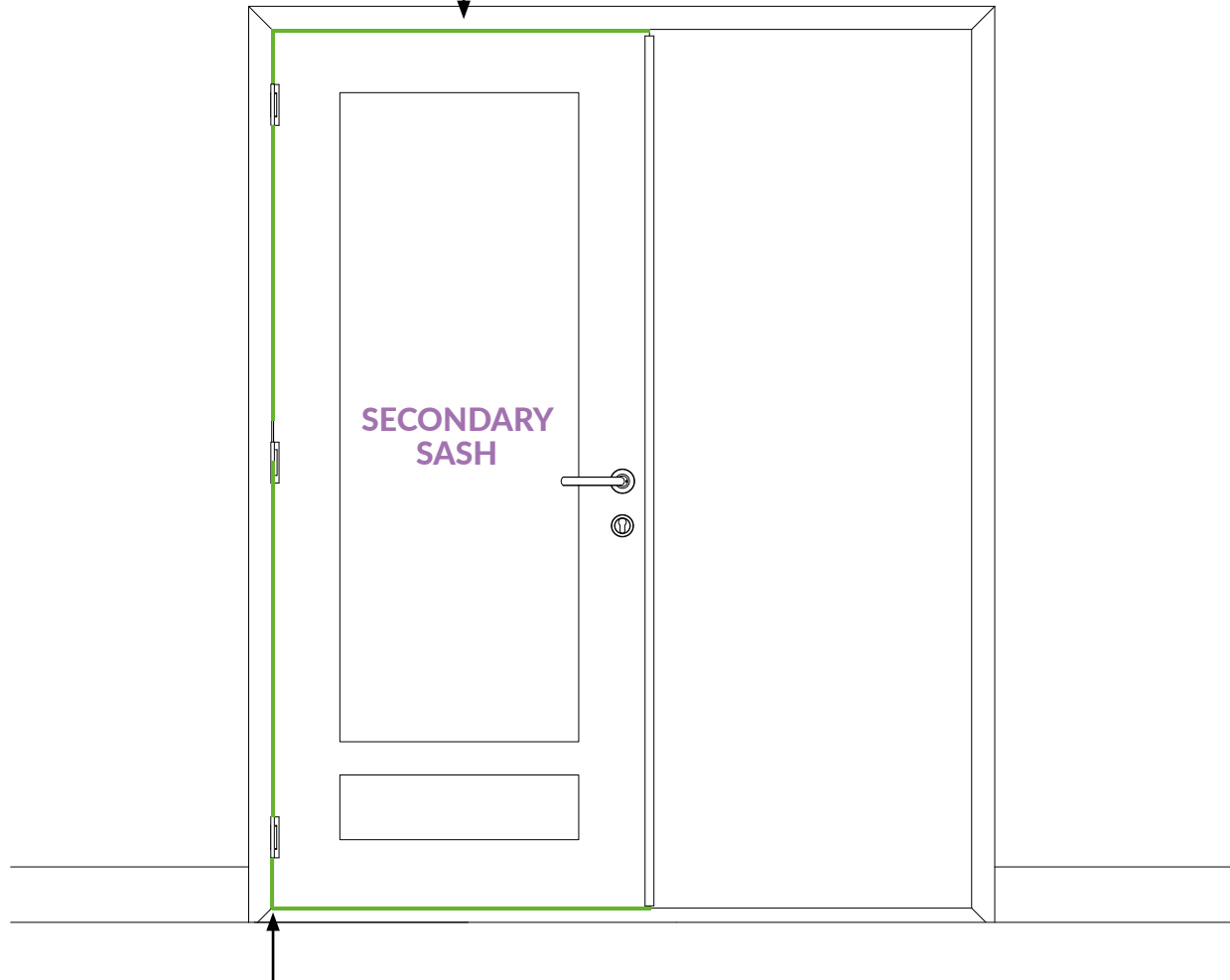

SIDE GAPS MUST BE PARALLEL



INSIDE VIEW

Re-check the hinge side for plumb



With a spirit level check both the front face and the rebate face of the frame on the secondary hinge side of the frame is still plumb.

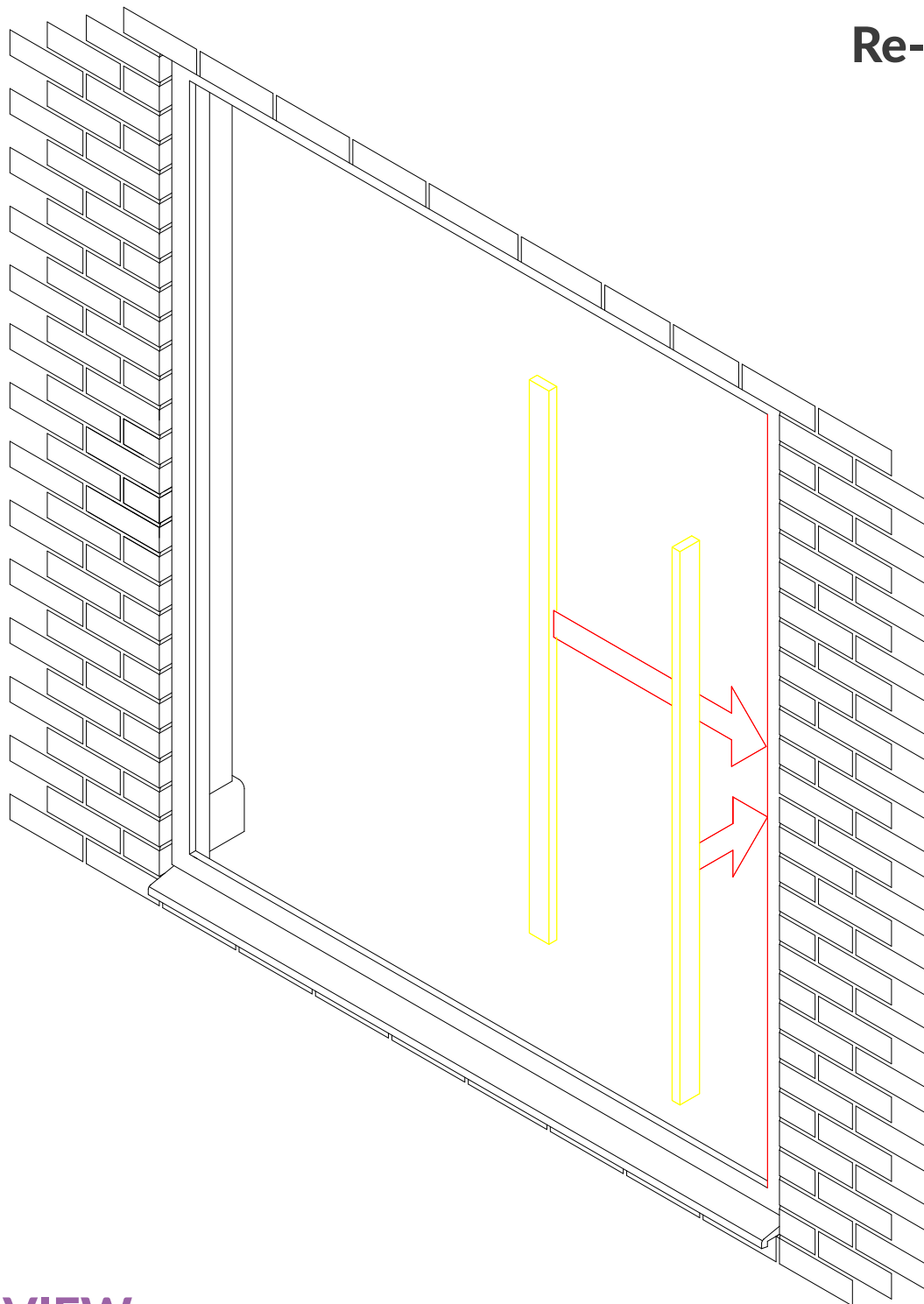

The first corner, secondary door

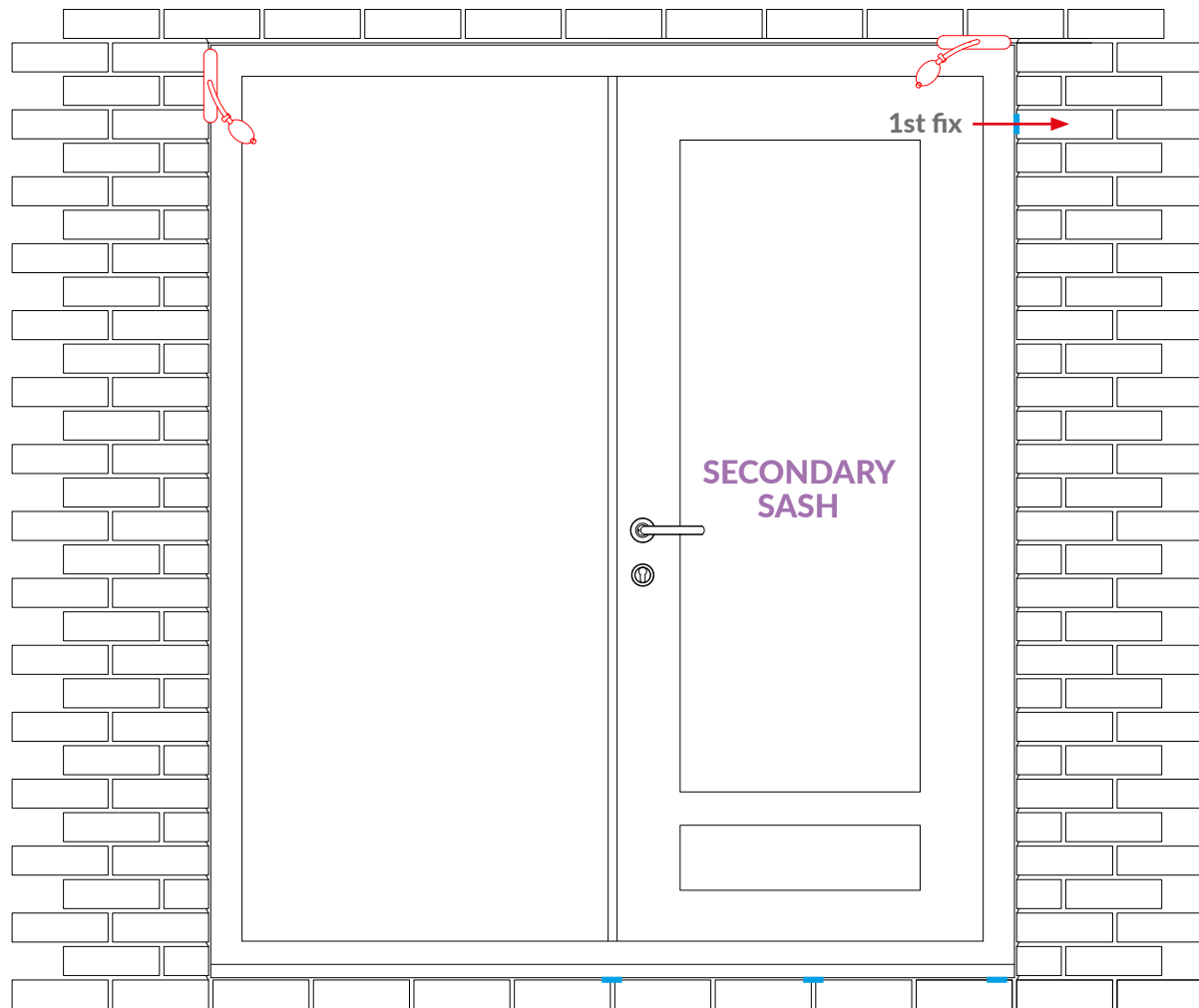

Make the first fixing above the top hinge into a full brick and through a packer.

Fix the threshold and head

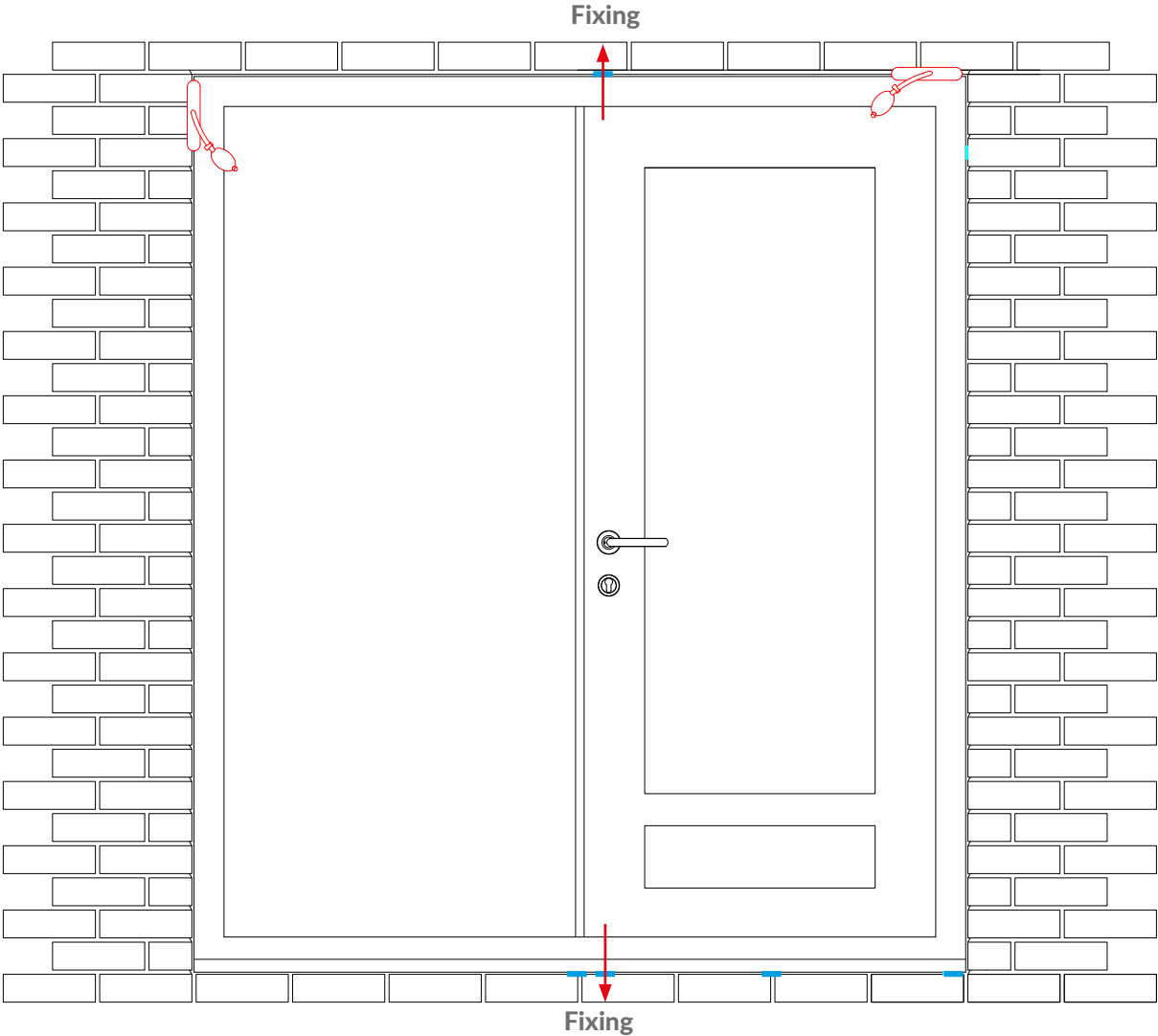

When fixing into the threshold, ensure that the fixing head is properly sealed and cannot foul any gaskets.

Ensure the head and side gaps are parallel.

It is crucial that the threshold is also parallel with the bottom of the sash.

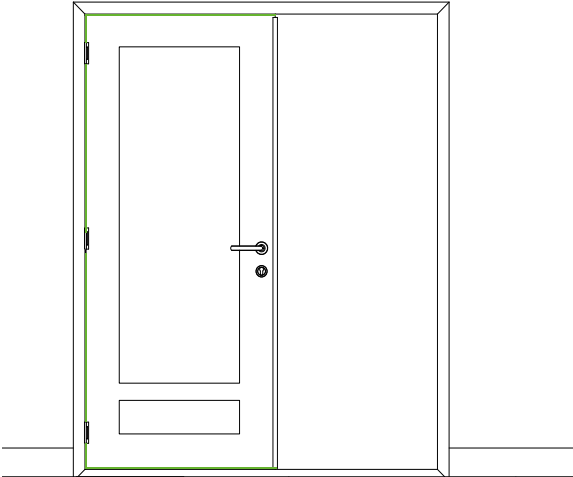

With suitable fixings, fix the threshold and the head in the positions indicated on the diagram.

More fixings may be required to keep the air gaps parallel.

OUTSIDE VIEW

The second corner, secondary door

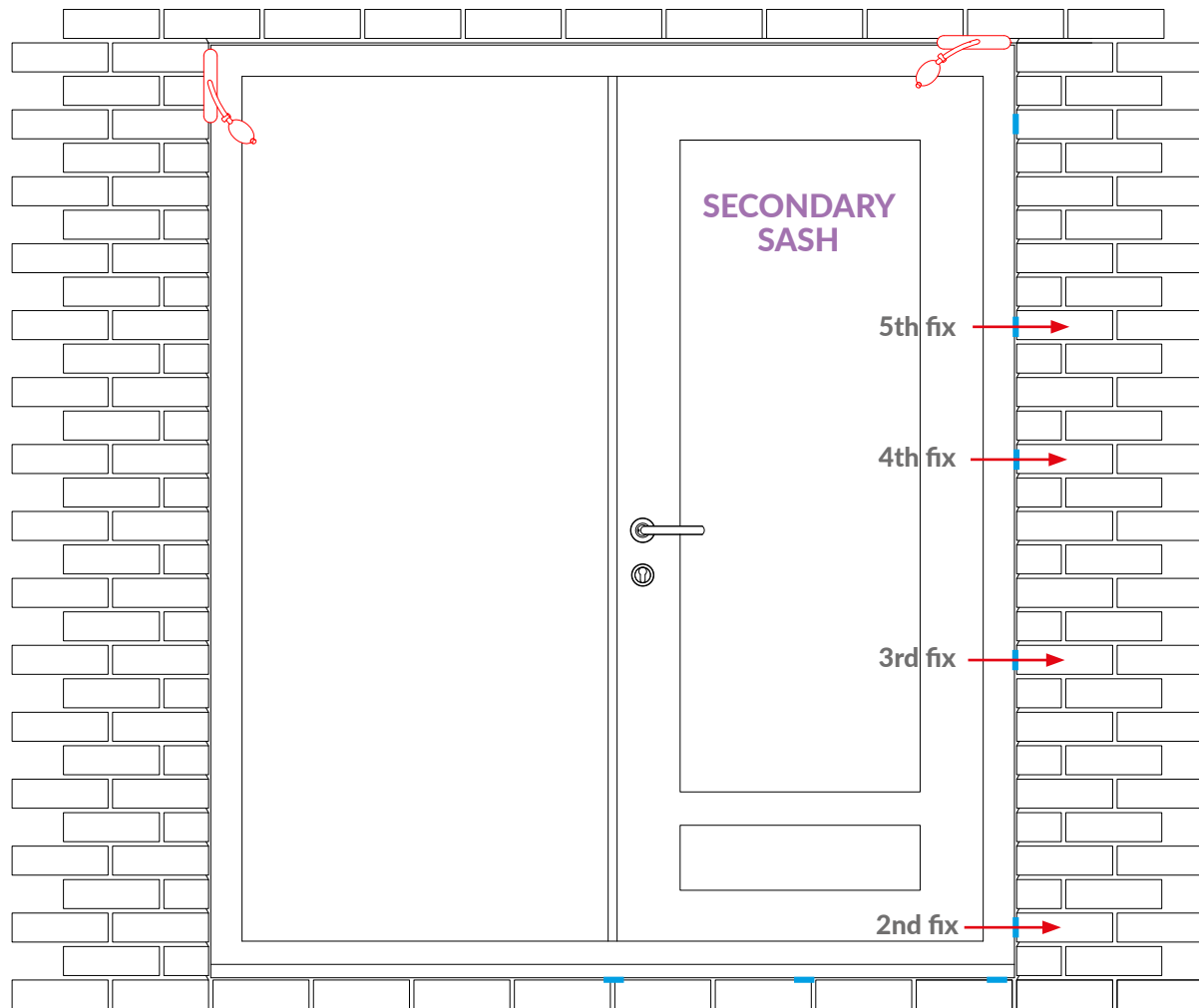

Make the second fixing below the bottom hinge into a full brick through a packer.

The remaining three fixings should be made at no more than 600mm centres and through packers into a full brick.

Pack behind the bottom hinge

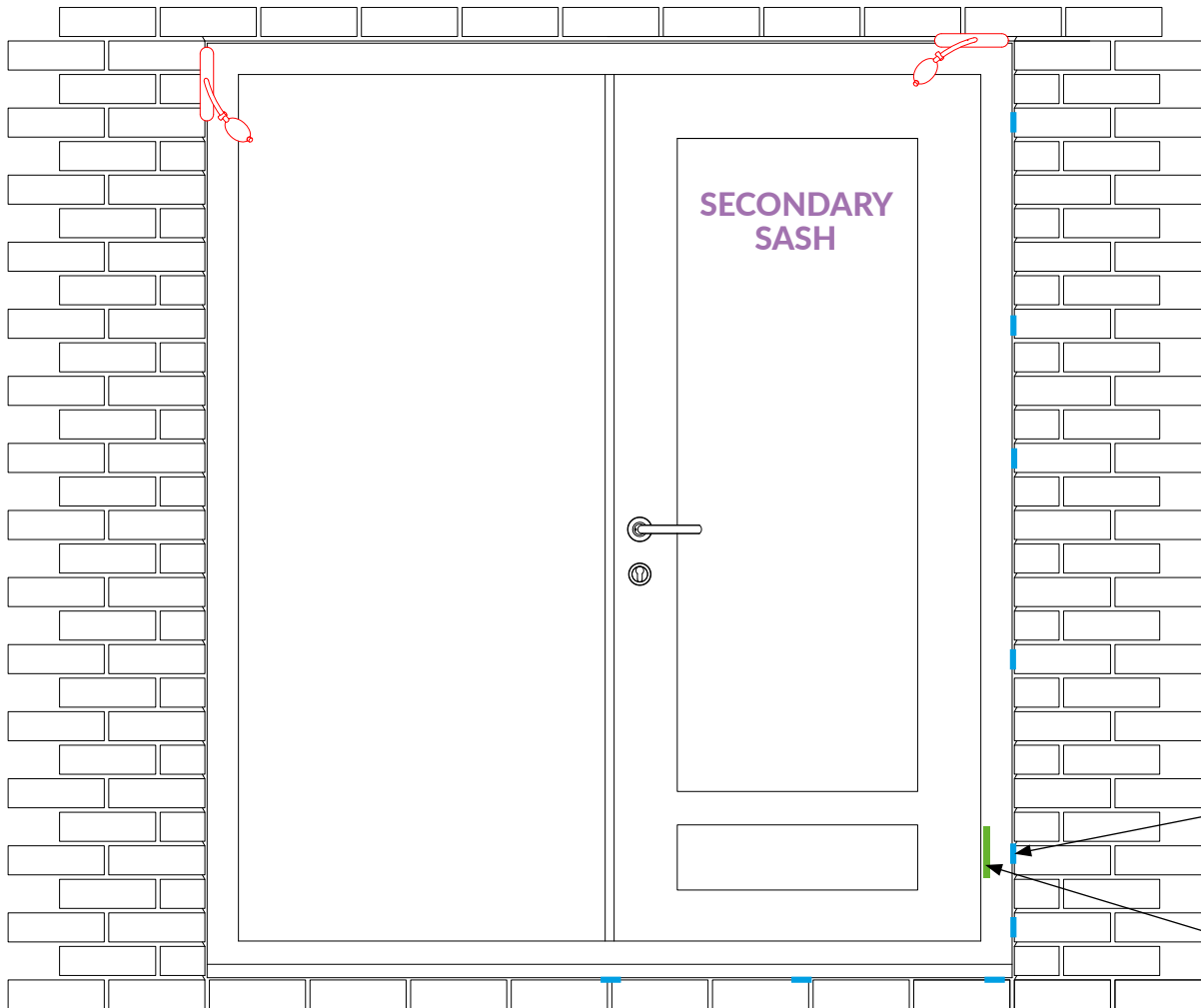

Pack between the frame and brickwork in line with the bottom hinge.

Packer

Bottom hinge position

Check and lock the shoot bolts



The secondary sash should now open, close and lock.

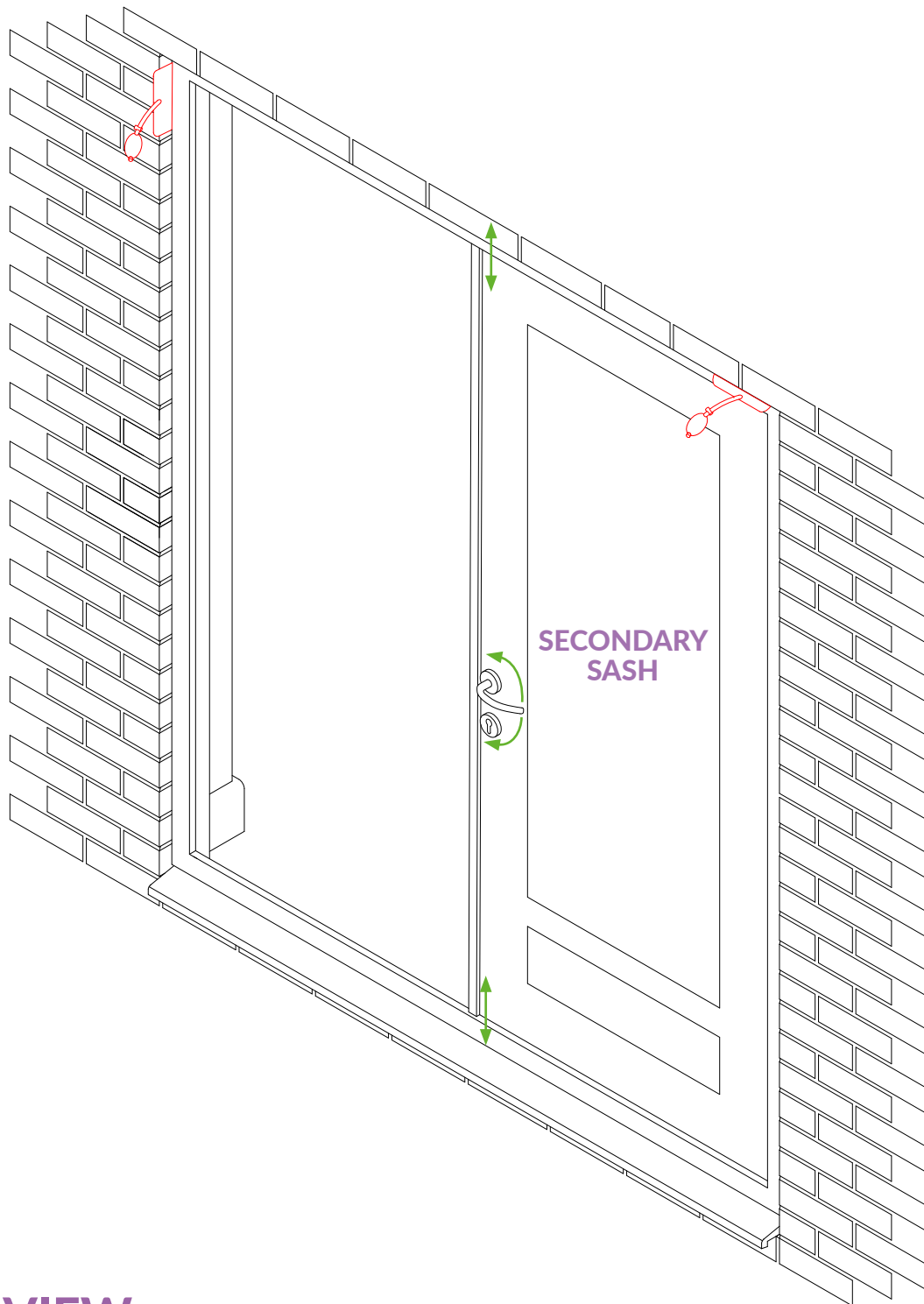

OUTSIDE VIEW

Reposition the winbags on the main sash side



RE POSITION THE WINBAG

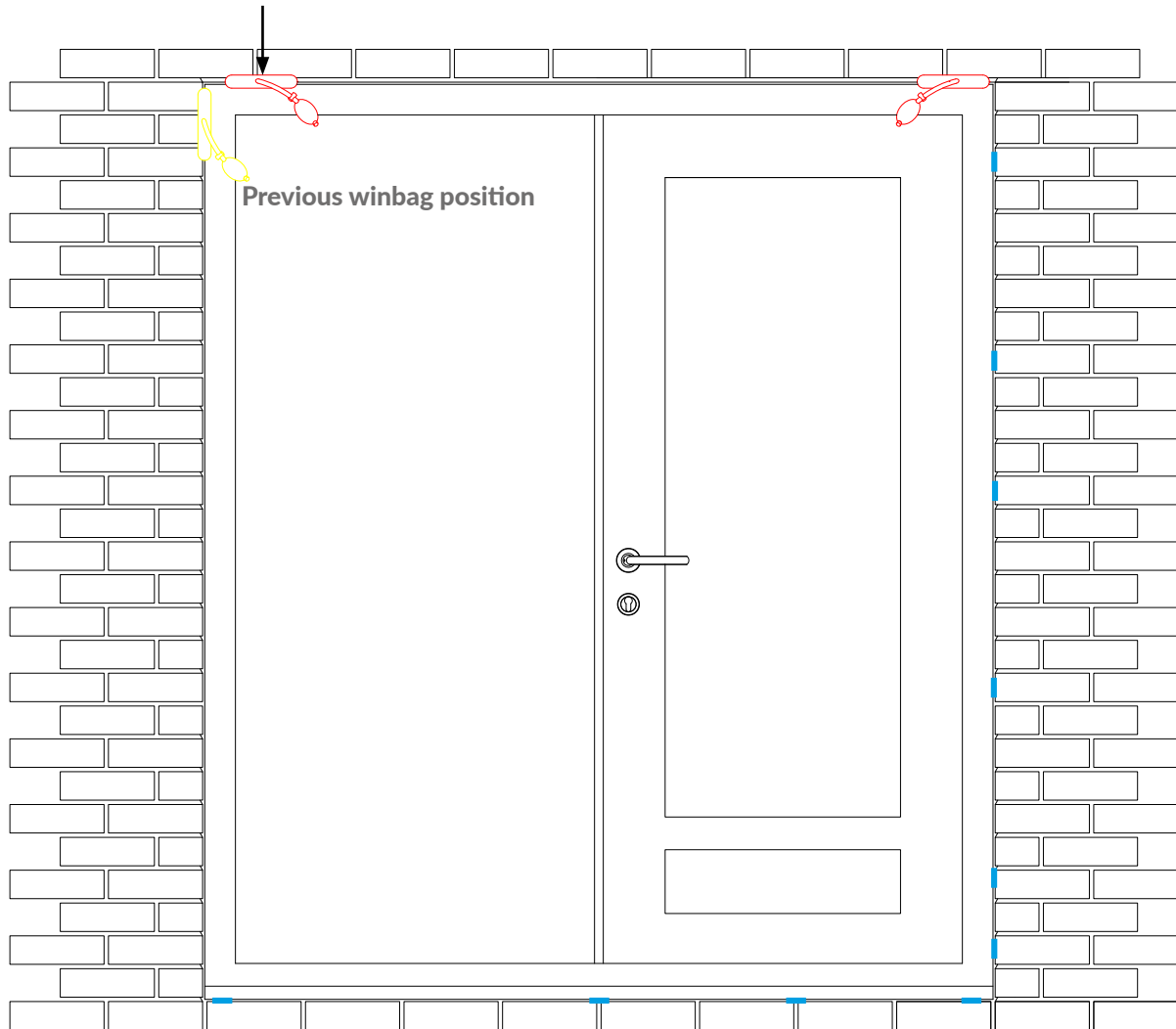

5mm packers in position

Place a packer under the frame leg for the master door.

Reposition the winbag to above the frame leg on the master door side and inflate to push the frame trapping the packer under the cill.

OUTSIDE VIEW

Re hang the main sash



It makes it easier to align if you remove the centre plate of the hinge using a 4mm allen key. Once the sash is in place insert the top and the bottom pins. Then refit the plate and then insert the middle pin.

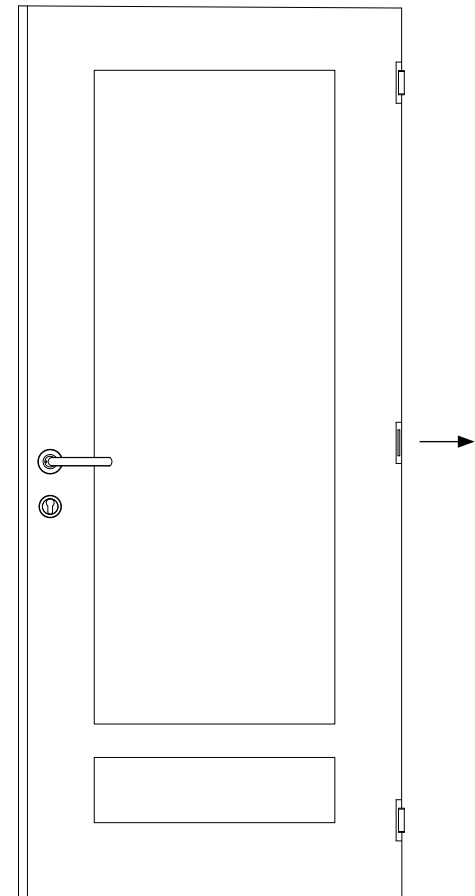
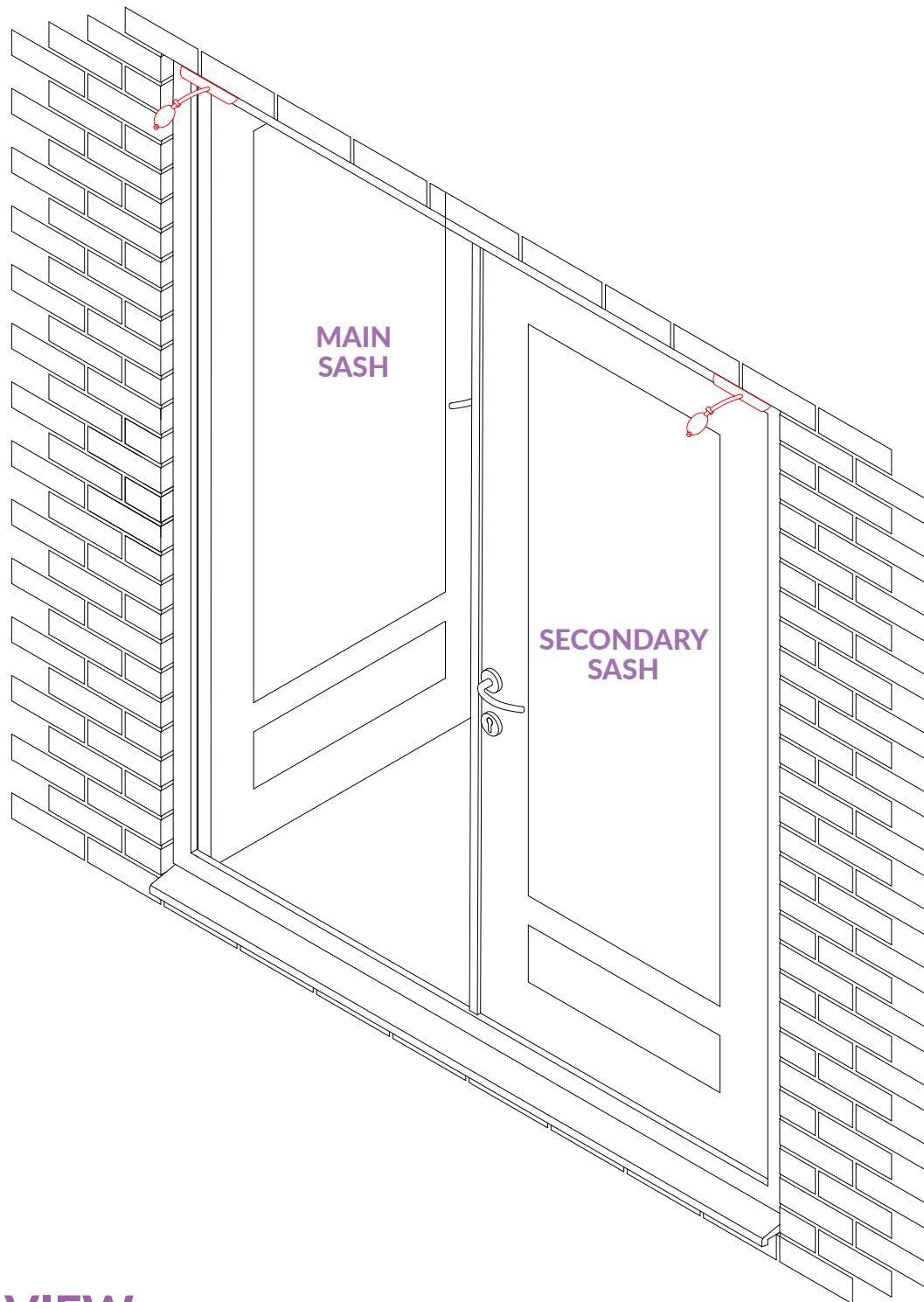

OUTSIDE VIEW

Pack under the main sash hinge side to achieve a parallel head gap



The side gap on the main sash must be parallel before you continue.

Check that the head gap inside is parallel, if it is not, repack with a different thickness packer until the head gap is parallel.

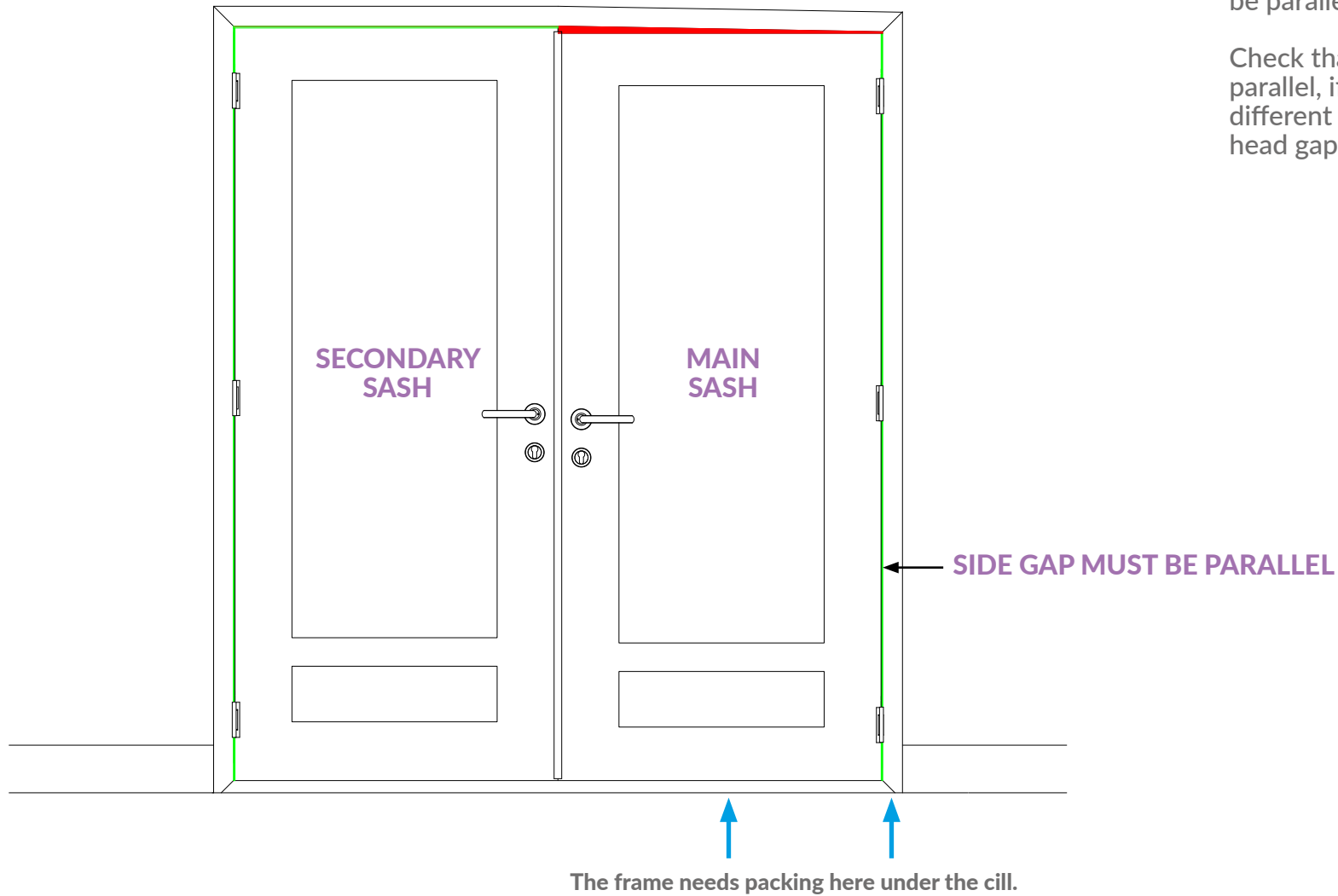

INSIDE VIEW

The head gap must be parallel before you continue

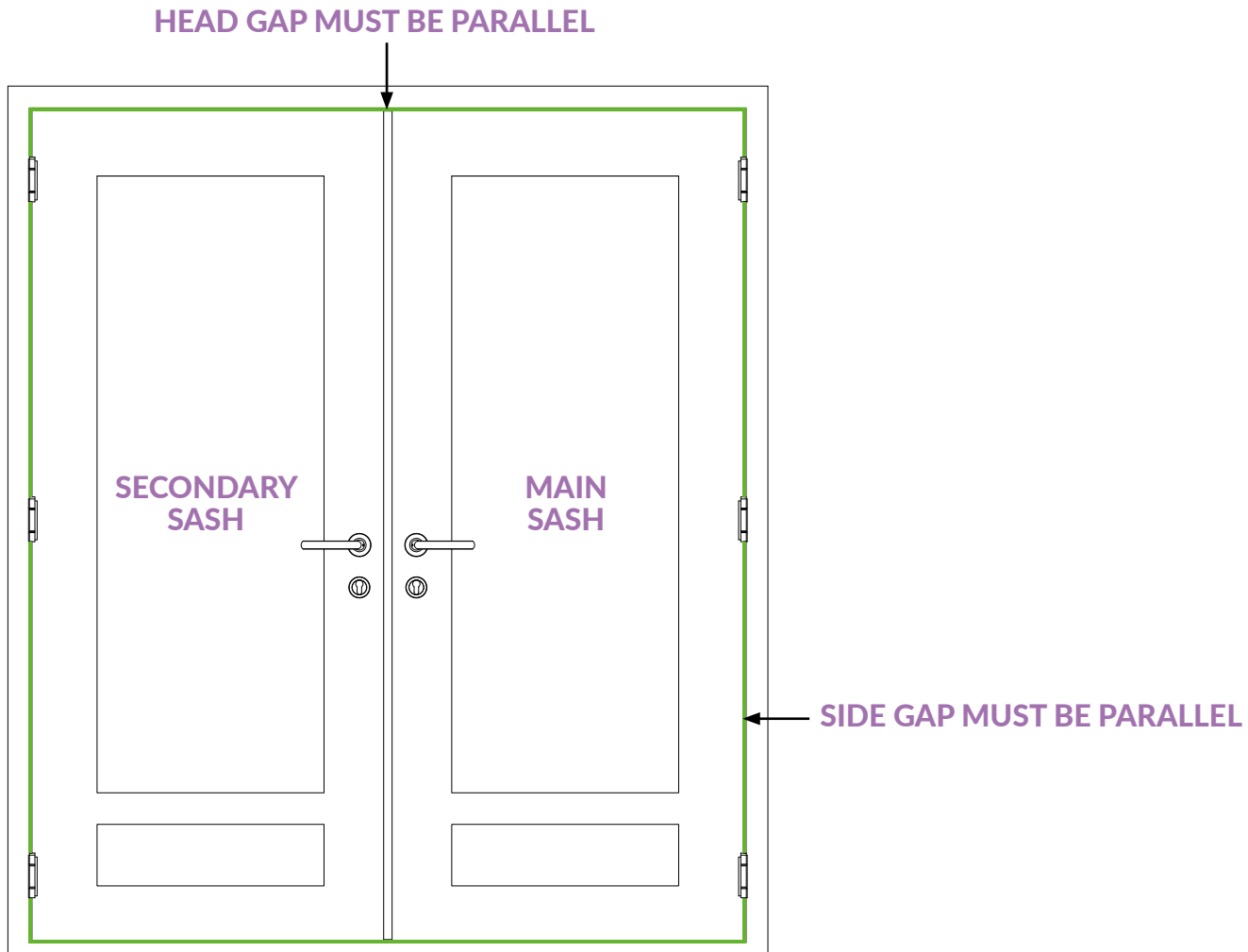

INSIDE VIEW

The third corner, master sash



Make the sixth fix below the bottom hinge into a full brick through a packer.

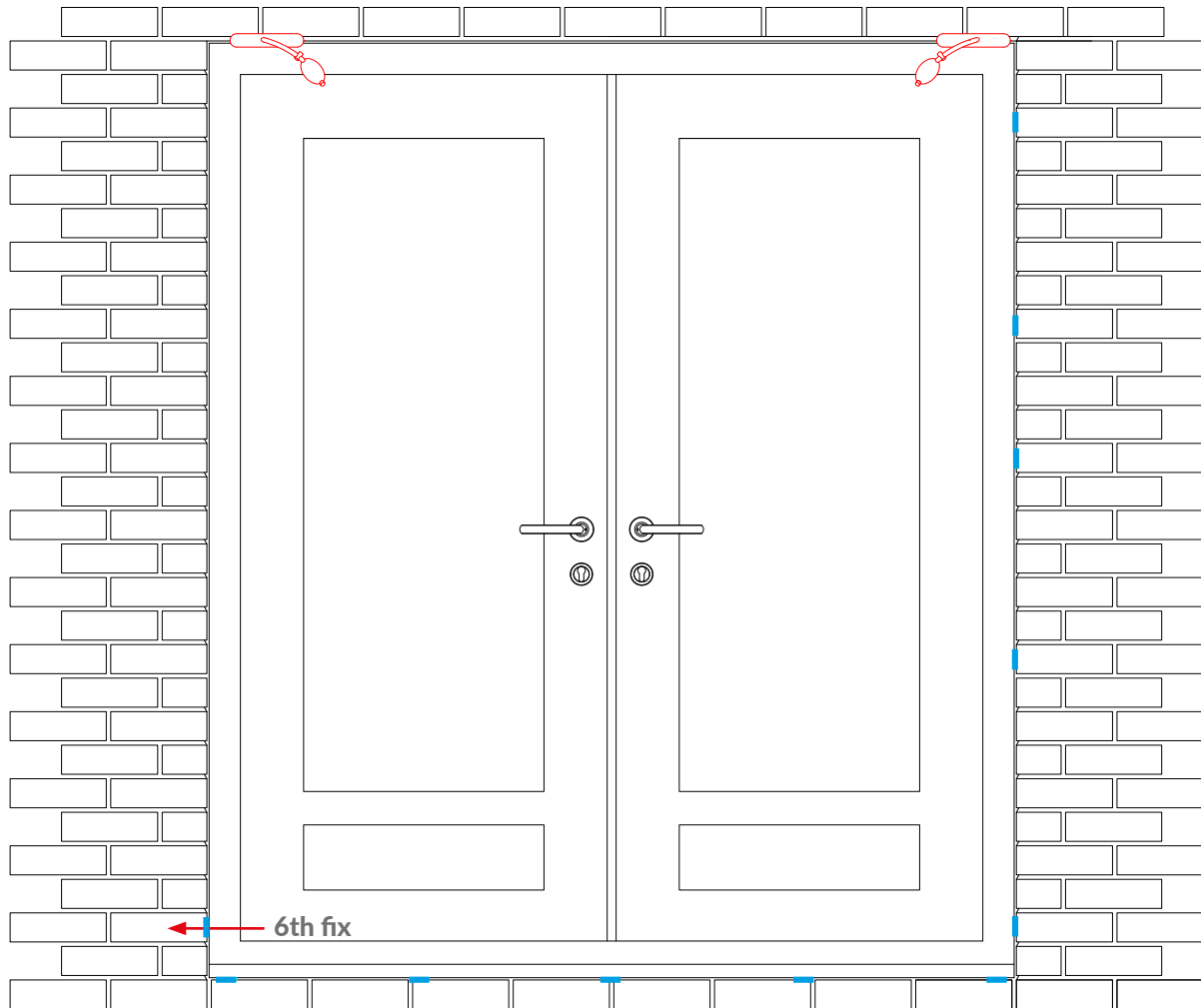

The viewing gap must be parallel



MOVE THE FRAME IN AND OUT UNTIL
THE VIEWING GAP IS PARALLEL

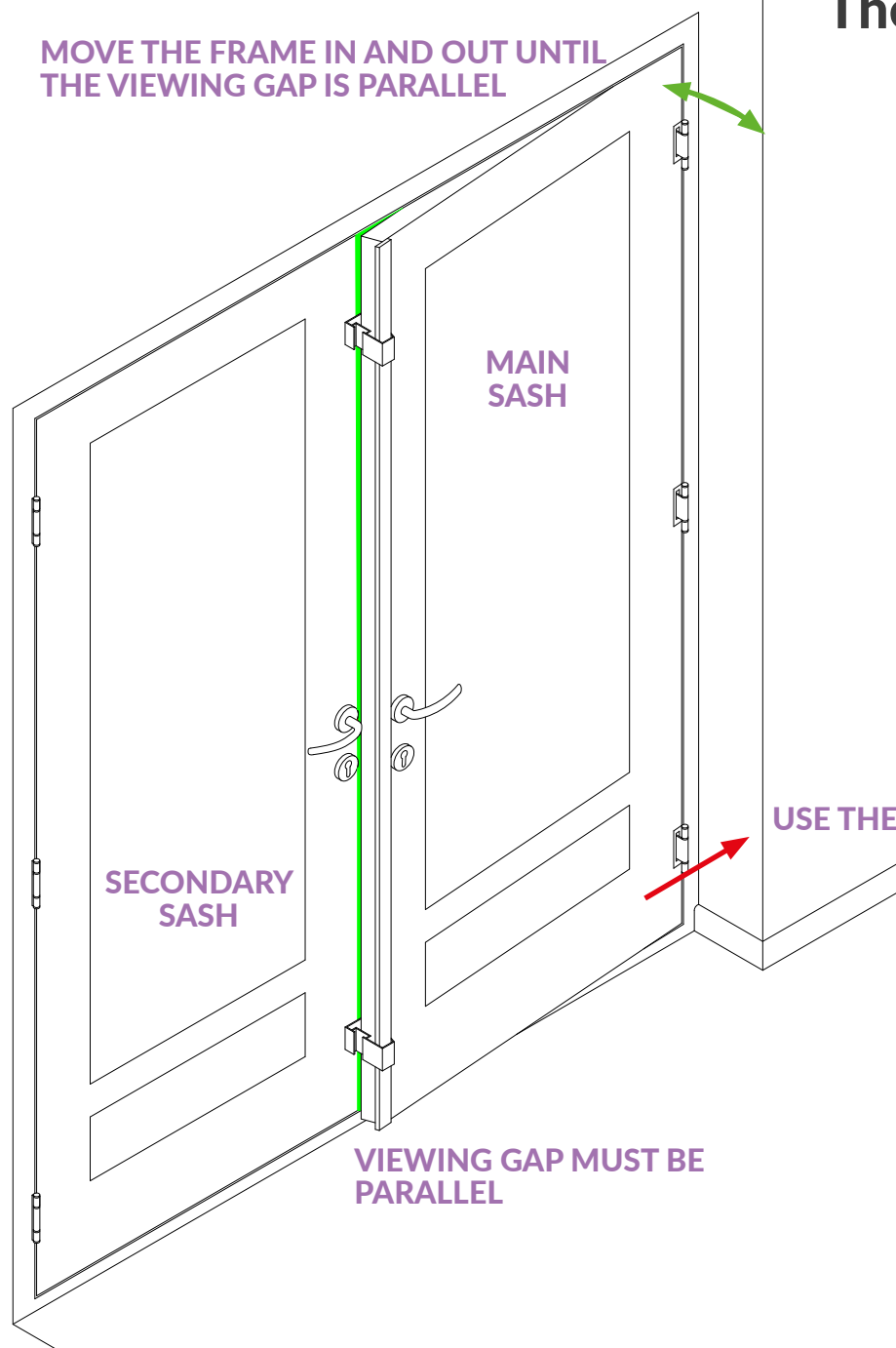

Slightly deflate the winbag, using the bottom fixing as a pivot move the frame in and out until the viewing gap is parallel for the full length of the door.

When it is parallel, re inflate the winbag to secure the frame in position.

The viewing gap must be parallel before you continue.

USE THE BOTTOM CORNER FIXING AS A PIVOT

VIEWING GAP MUST BE
PARALLEL

INSIDE VIEW

The fourth corner, master sash

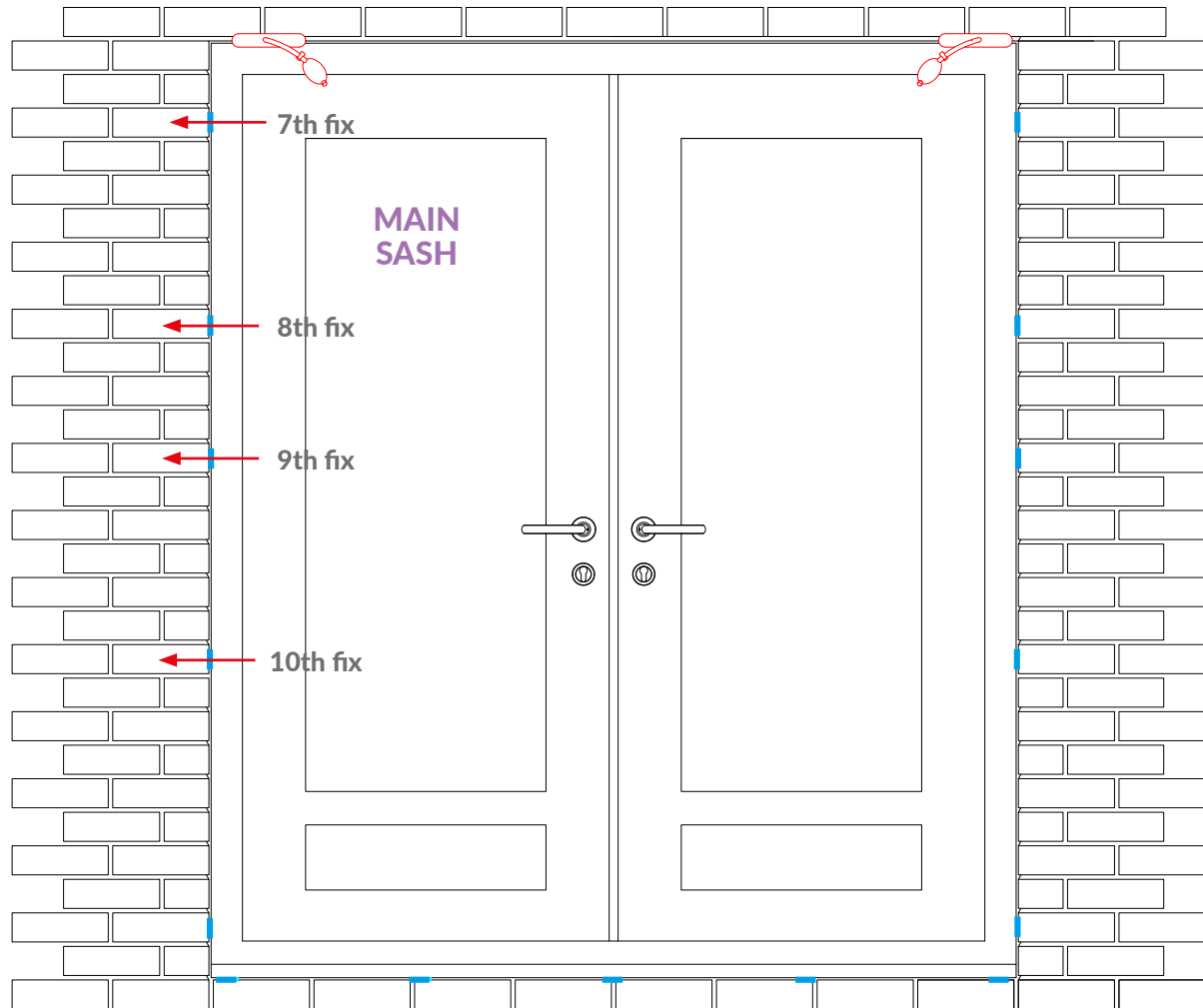

Make the next fixing above the top hinge into a full brick through a packer.

Check the viewing gap is still parallel.

The remaining three fixings should be made at no more than 600mm centres and through packers into a full brick.

Pack between the frame and brickwork in line with the bottom hinge.

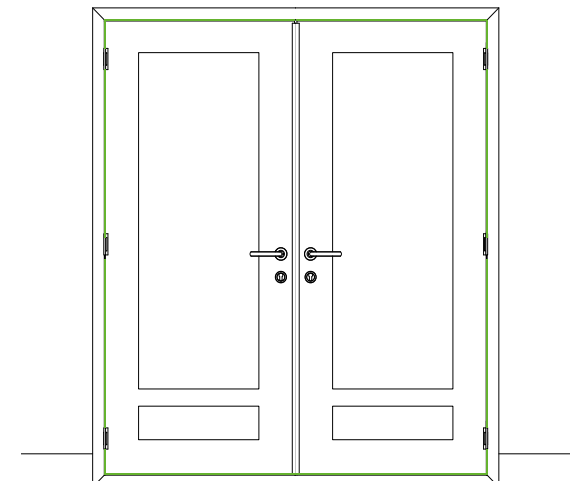

The air gaps must be parallel.

Pack behind the bottom hinge

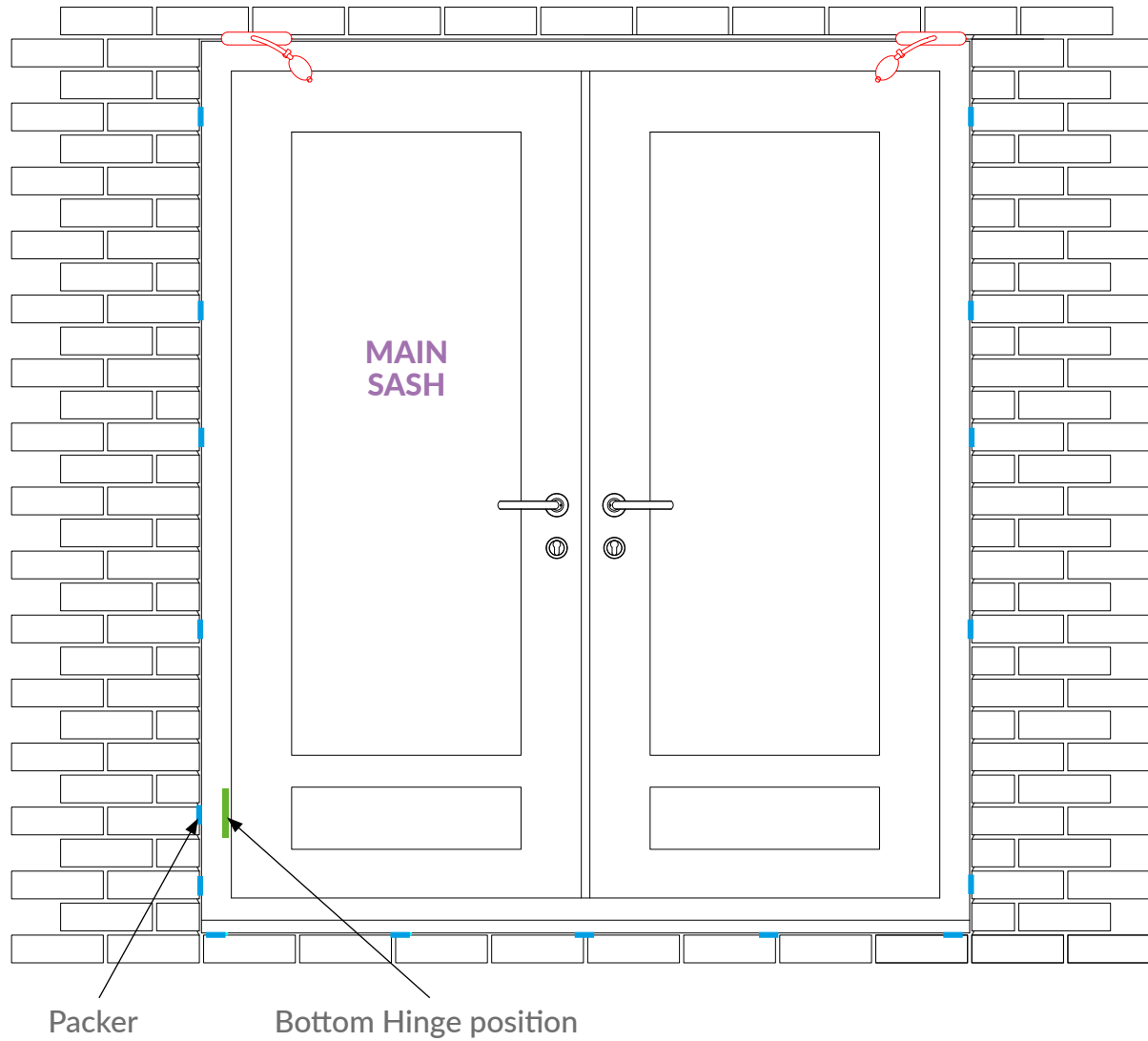

Pack between the frame and brickwork in line with the bottom hinge.

Fill the gaps

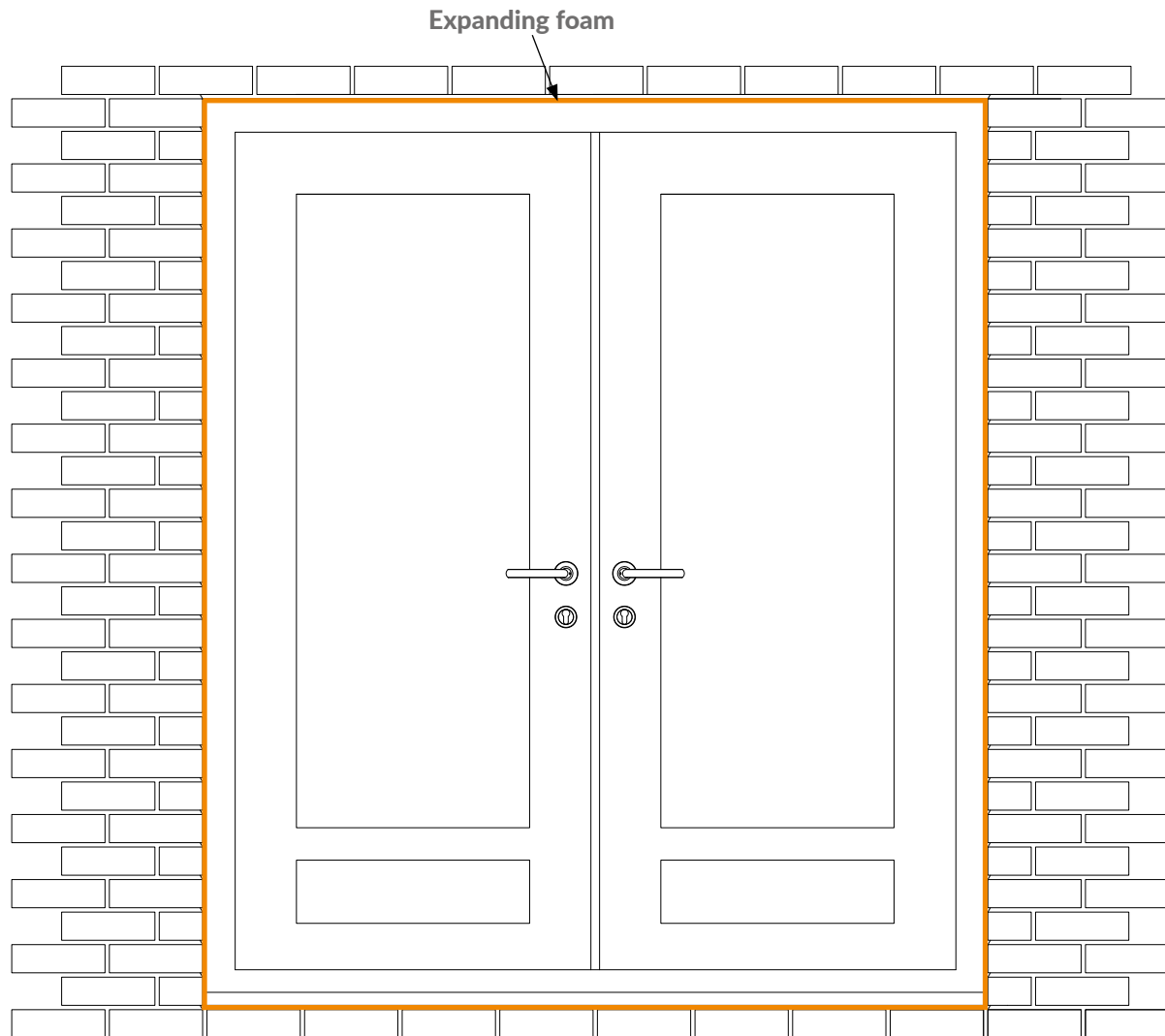

The viewing gap must be parallel before you continue.

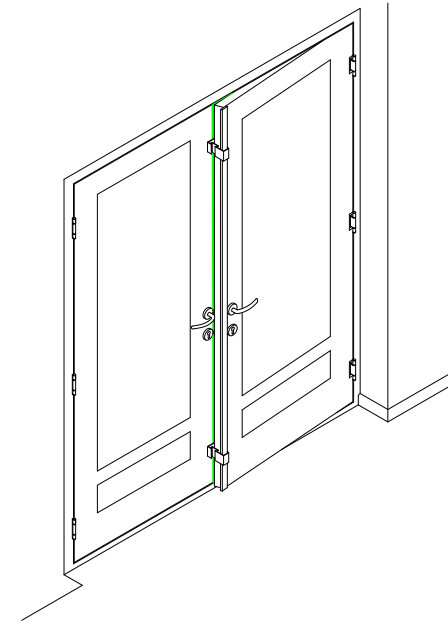

Apply expanding foam in the gap between the frame and the brickwork to form a thermal break.

When the expanding foam has skinned over, use a packer and carefully push any excess back into the gap.

When the expanding foam has fully cured seal and trim.

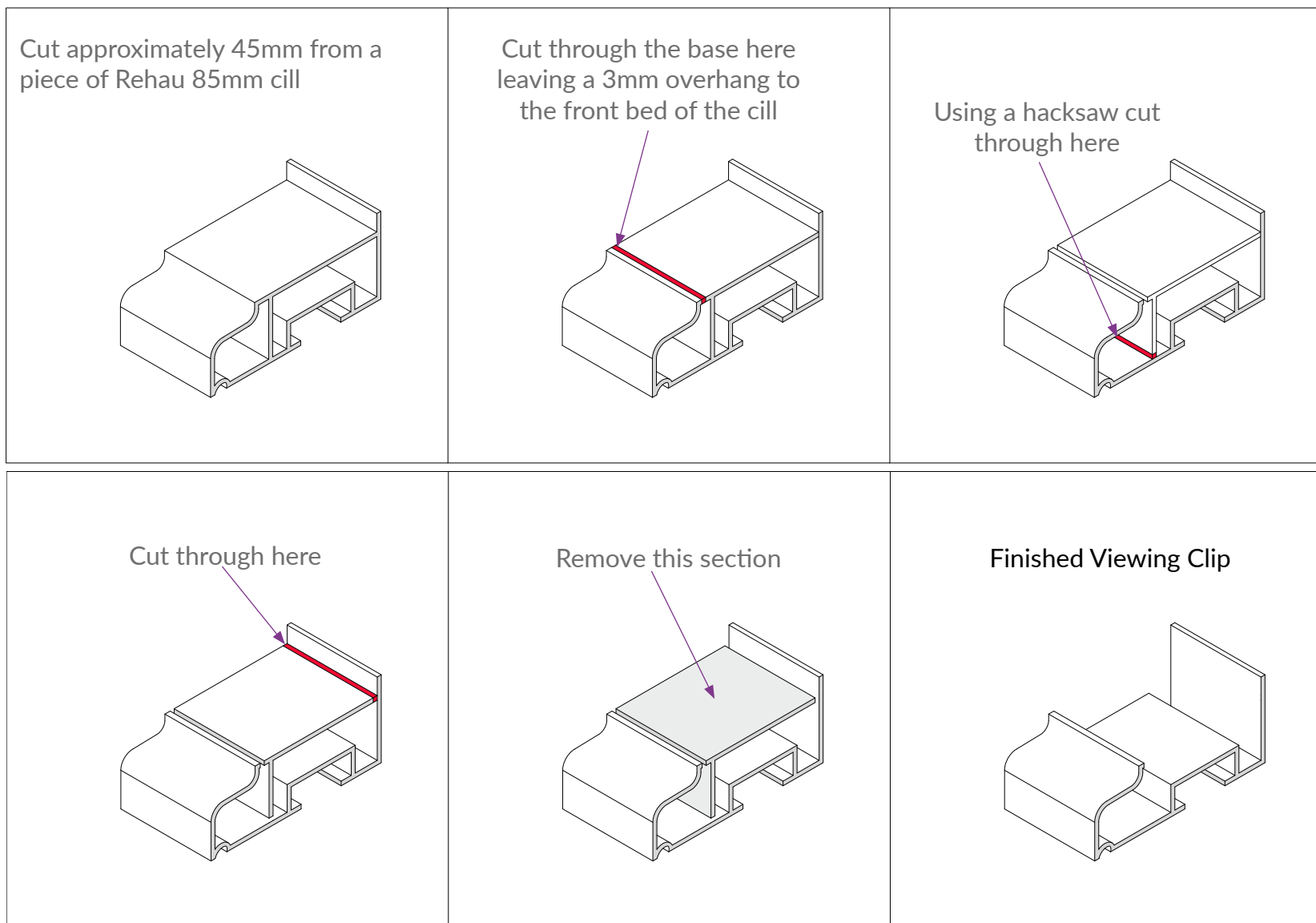

Download the **5 Star Installation Guides**, there you can find full instructions on how to get the best from your viewing clips.

www.gap.uk.com/about-gap/brochure-download/rockdoor-brochures



FIVE STAR INSTALLATION CHECKS

The Rockdoor' will operate correctly and will be trouble free, if you can tick yes to all the following checks.

1 HEAD GAP CHECK

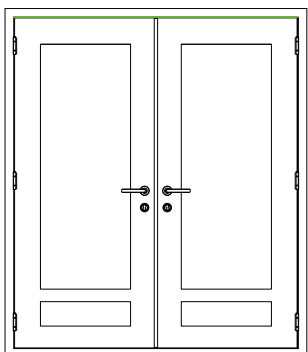

The head gap must be parallel.



2 SIDE GAPS CHECK

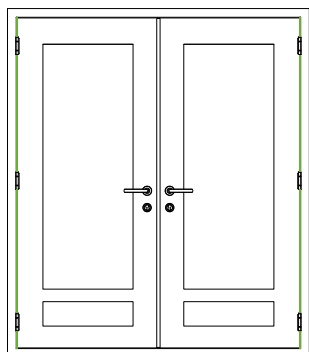

The side gaps must be parallel.



3 VIEWING GAP CHECK

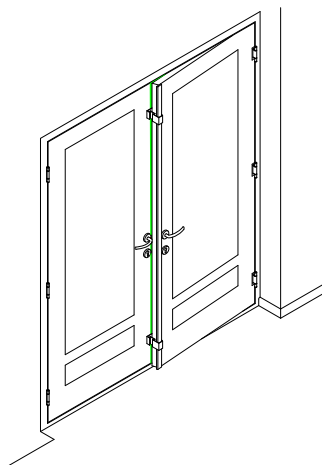

The viewing gap must be parallel.



4 OPERATION CHECK

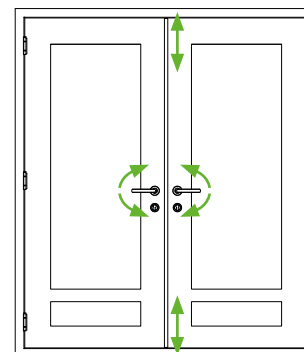

Both doors should open, close and lock smoothly.



5 HINGE LOCK CHECK

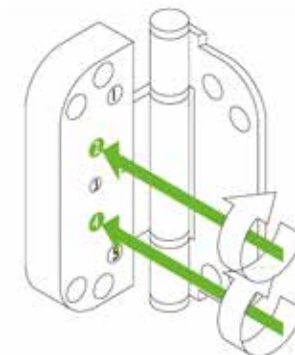

All 6 hinges should be locked.



If you can't tick yes to all the five star checks
please refer to the five star trouble shooting guide at:
www.rockdoor.com/five-star-trouble-shooting

ROCK
DOOR



PROTECTING
HOMES SINCE
1997