

ROCKDOOR INSTALLATION GUIDE



Five Star Installation Guide



Rockdoor's Five Star Installation Guide

From Preparation Essentials through to our Five Star Installation Checks, our simple step-by-step guide to installing a Rockdoor will ensure a smooth hassle free operation and complete customer satisfaction.

We have designed our installation instructions around 5 simple key checks which are **1 - Head Gap, 2 - Side Gap, 3 - Viewing Gap, 4 - Operation and 5 - Hinge Lock**. If you can tick off each of these checks, the Rockdoor will perform as expected.

1 HEAD GAP CHECK

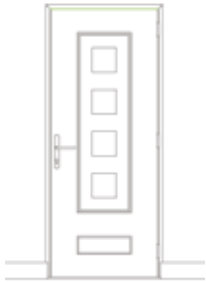

Head gap should be 4mm

2 SIDE GAP CHECK

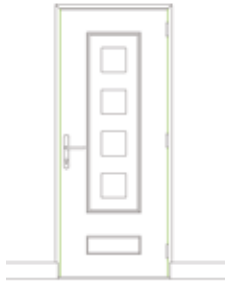

Side gaps should be 4mm

3 VIEWING GAP CHECK



The viewing gap must be parallel.

4 OPERATION CHECK



The door should open, close and lock smoothly.

5 HINGE LOCK CHECK

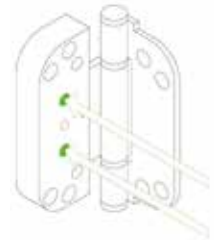

All 3 hinges should be locked tight.

Help Needed?

For installation tolerances or should you encounter any problems, please refer to our **Trouble Shooting Guide** available from our customer service team or by visiting www.rockdoor.com/five-star-trouble-shooting

Step-by-Step Five Star Installation Guide

Preparation Essentials

1 Check the Door

- Check the door is the correct size and specification.
- Remove the packaging and check for any damage whilst ensuring items such as handles, cills and end caps are present.

2 Remove Keys

- Remove keys from the side of the door and put them in a safe place.
- If it is a key wind lock put one key in the cylinder on the outside.

3 Side & Head Gaps

- Check that the side gaps and head gap are 4mm and parallel and adjust if required.

4 Dressing the Door

- Dress the door with furniture supplied loose.
- Ensure the threshold fixings are tightened.
- If a cill is required prepare it for the opening (cill horns help prevent water ingress into the brick work).
- Attach cill to ensure the frame legs are held in place and to suit the opening.
- Position cill to ensure the frame will sit square in the opening.

5 Cover and Protect

- Cover and protect the flooring and reposition any furniture close to the installation.

6 Remove the Old Door

- Remove the old door without causing any damage to the property. Clean the opening ready for the new Rockdoor.

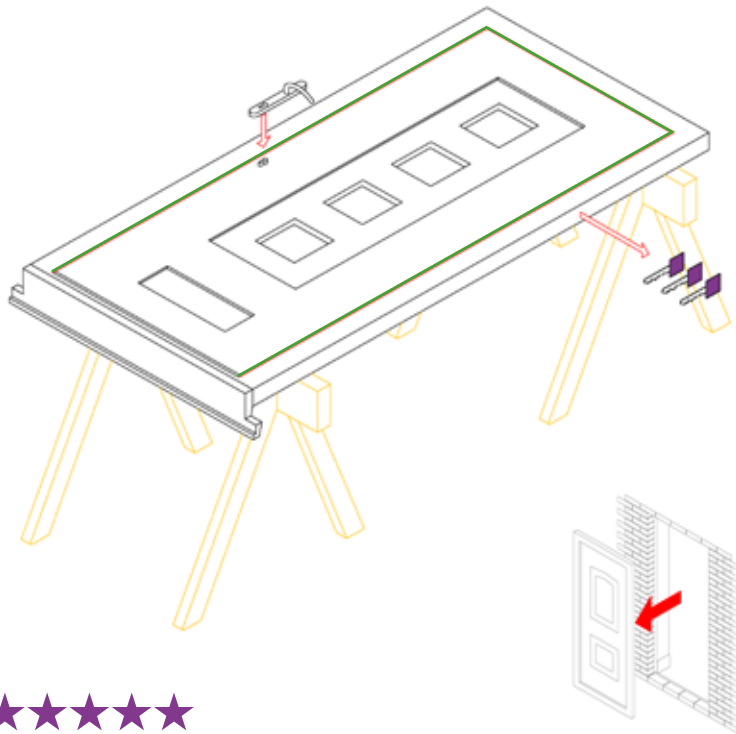

7

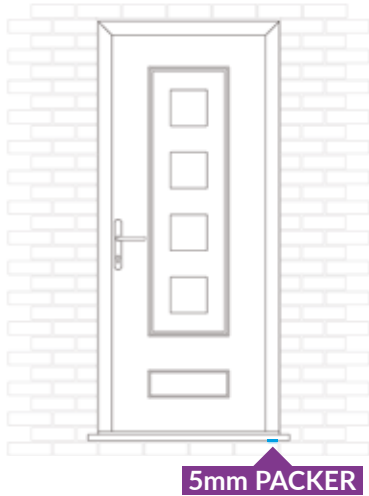

On the **hinge side** place a 5mm packer between the cill and the brick work. Offer the door into the aperture.

8



Pack between the brickwork and frame just above the top hinge and insert and inflate the Winbag on the opening side of the frame and inflate enough to hold the packer in place.

9

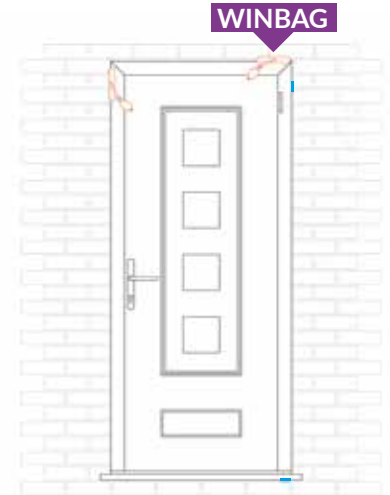

Insert and inflate the Winbag over the **hinge side** to compress the frame down onto the 5mm packer.



10 Viewed from **INSIDE**

Head gap not parallel

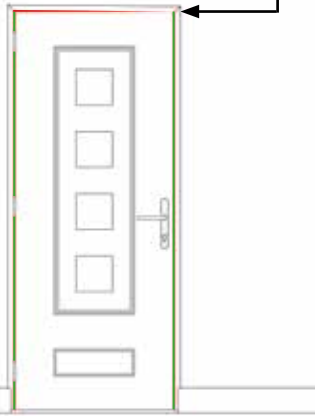

Side gaps must be parallel

11 Viewed from **OUTSIDE**

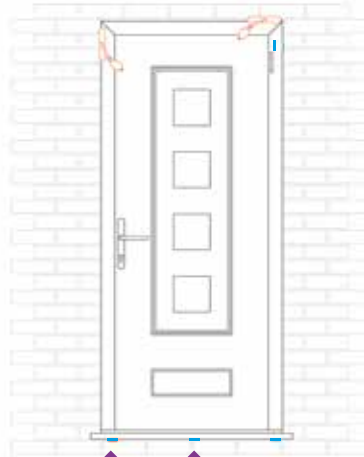

PACK

Pack under the cill to achieve a parallel air gap to the head.

12 Viewed from **INSIDE**

Head gap must be parallel

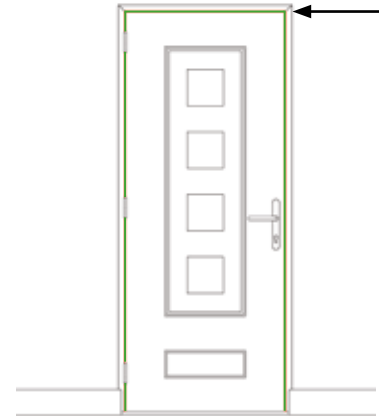

Side gaps must be parallel

There **must** be a parallel air gap to the head and along both sides of the door before you continue onto the next stage.



13

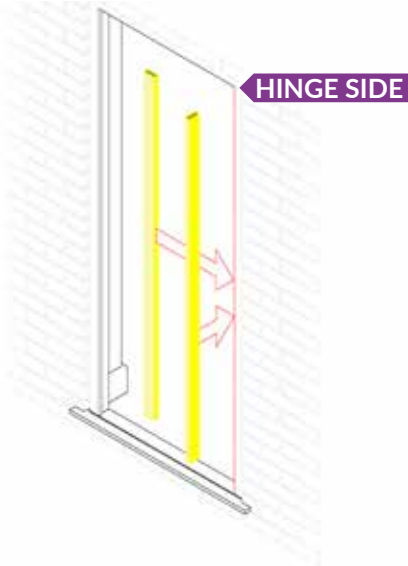

Plumb the hinge side. Leave a small gap to the plaster line to allow for setting the peep gap.

14

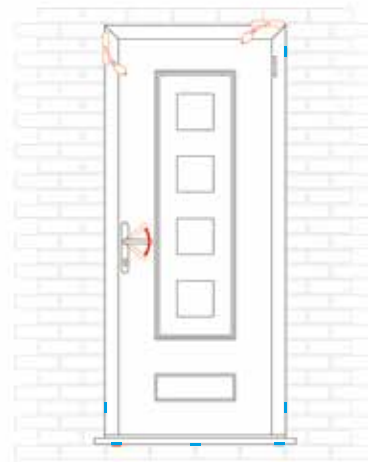

Check the operation of the door lock and latch.

15

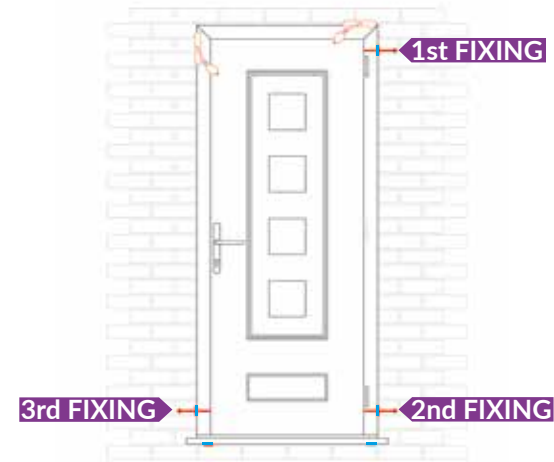

Make a fixing as close as possible above the top hinge through the packer. Drill and fix below the bottom hinge through the packer. Drill and fix through the bottom of the closing side, through the packer.



16 Viewing clips make it easy

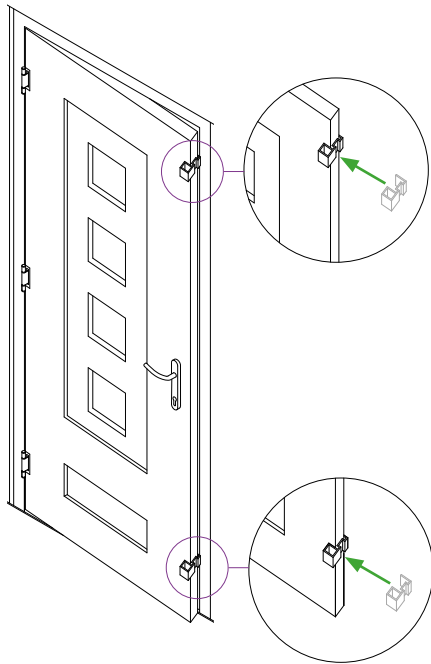

Move the frame in or out to get the viewing gap parallel.

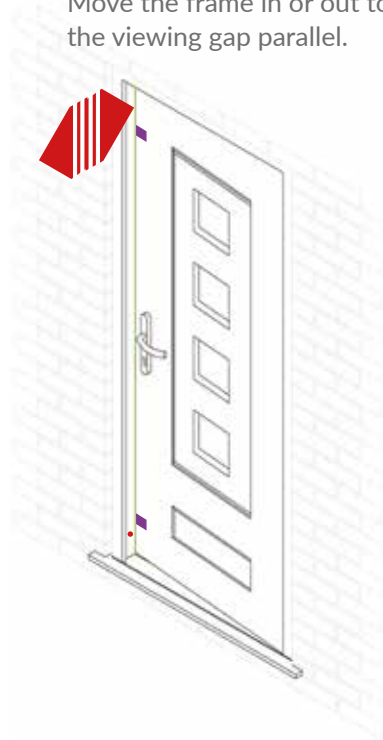

Place on the viewing clips to the top and the bottom of the sash. Close the door up to the frame and move the top part of the frame using the bottom fixing as a pivot, until both viewing clips are touching the frame- the viewing gap should now be parallel. When the viewing gap is parallel, clamp the frame with a winbag.

17 Viewed from **OUTSIDE**

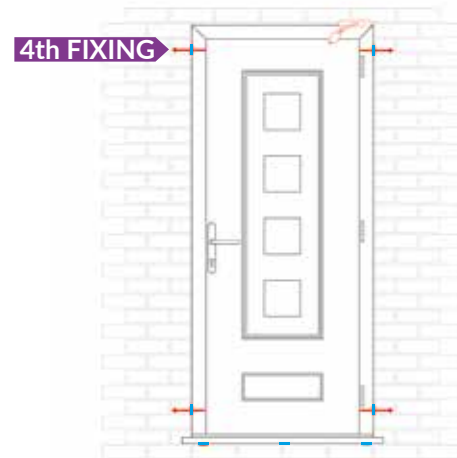

Drill and fix through the top of the closing side, through a packer.



18

Check the lock mechanism to ensure that nothing has moved and the door still functions correctly.

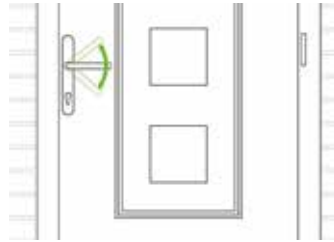

19

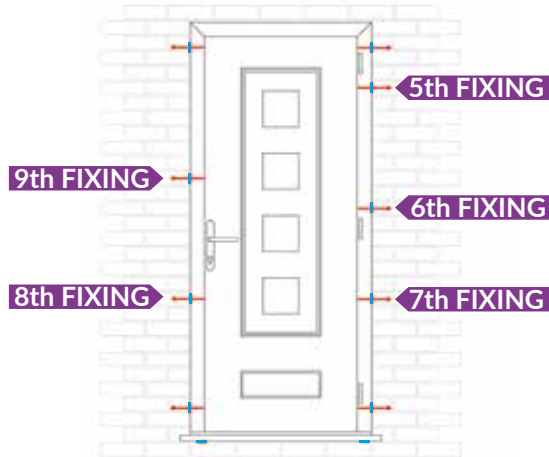

Drill and fix through a packer for the remaining 5 fixing positions. After each fixing, check the lock mechanism to ensure that nothing has moved and the door still functions correctly.



20

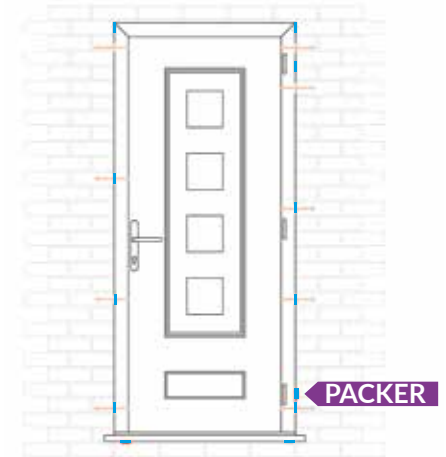

Packing directly behind the bottom hinge stops the weight of the door deflecting the frame in the future.

21 Hinge Lock

Use a 4mm allen key and lock tight positions 2 and 4 on **ALL THREE HINGES**

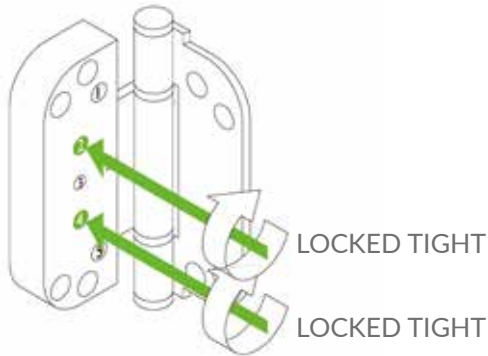

ALL 3 HINGES SHOULD BE LOCKED TIGHT.

21 Finishing

- Inject expanding foam into the gap between the door frame and the brickwork, this should go round the full perimeter of the frame helping to form a thermal break.
- Once the foam is sufficiently set, remove the protective films.
- Use silicone to seal and trim around the perimeter.
- Clean and tidy any mess and remove all the rubbish.



Hinge Adjustment

Whilst hinge adjustment shouldn't be required, they can be adjusted in 3 different directions if necessary.

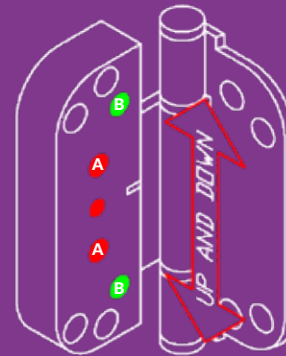

Up and Down -A
In and Out -A
Left and Right -B

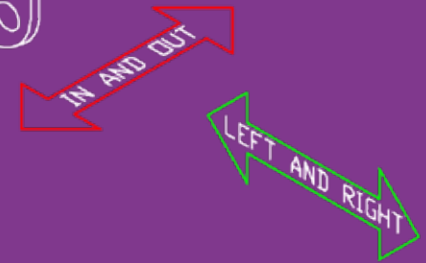

BAR HANDLE

1. From the inside slide the non threaded brass ferrule over the 8mm fixing bolt so the counter sunk head fits into the counter sink of the ferrule. Slide the fixing bolt through the pre drilled hole in the Rockdoor.

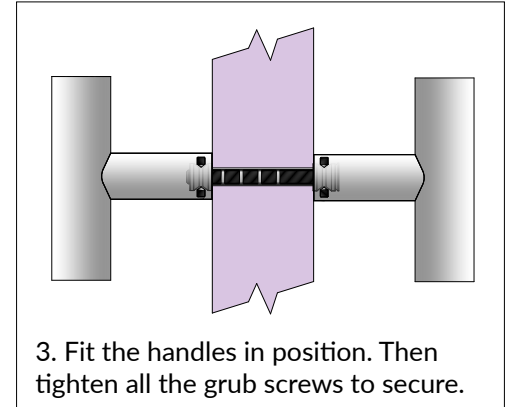
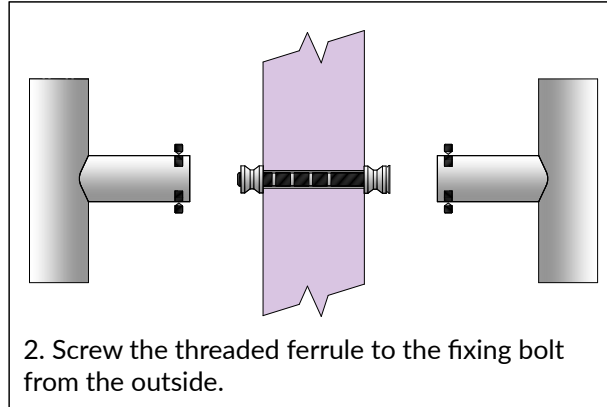
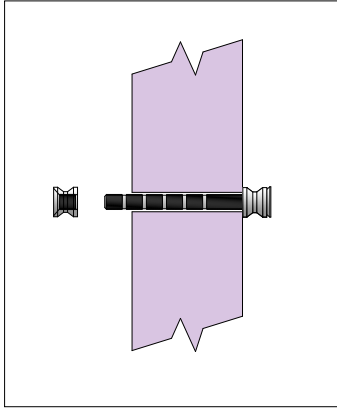

STAINLESS STEEL HANDLES AND ROSE HANDLES

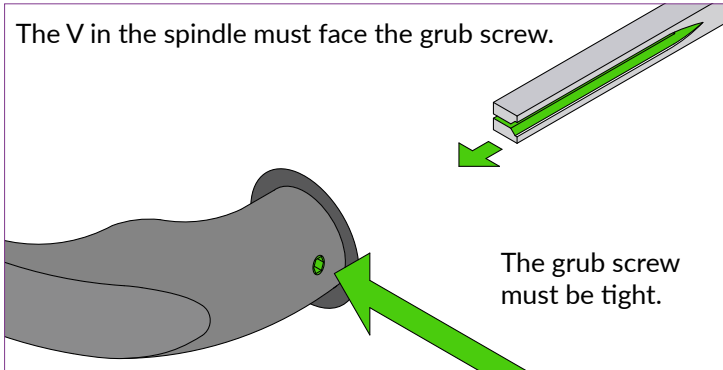

WROUGHT IRON HANDLES

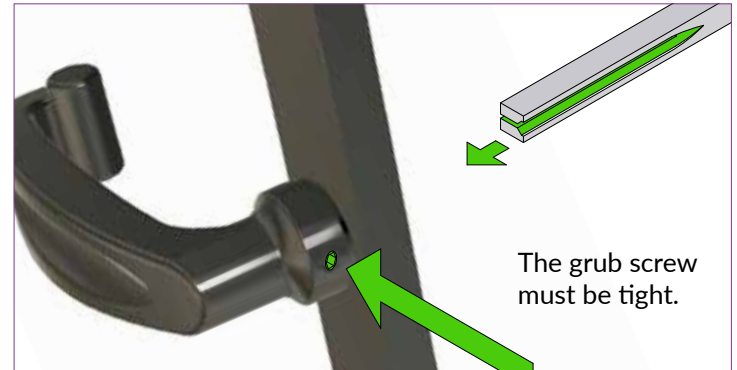

Insert the spindle so the exposed dish (or spindle groove) as shown in green, faces the grub screw. Then tighten the grub screw clockwise to 'splay' the spindle and secure the handle in place. Split spindles must **NOT** be used with these types of handles.

SWITCH LATCH

The best of both worlds

The switch latch allows you to set your lock so that the latch secures the door in place when opening and closing in a similar way to how a split spindle or night latch operates. Alternatively, you can set it so it can open and close freely like a roller latch.

This ensures the best of both worlds, by combining the benefits of a roller latch and split spindle in one smart innovation.

To secure your door fully, you'll still have to use your key internally (or thumbturn) to fully engage the hook locks.

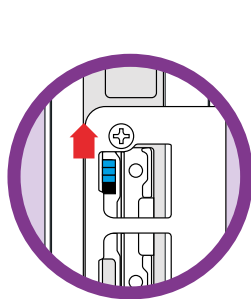

UP

When the Switch Latch is in the **UP** position, a key is required to gain entry to the property. Don't get caught out and lock yourself out.

For total security, the key or thumbturn still needs fully engaging to ensure the hook locks are secured in place.

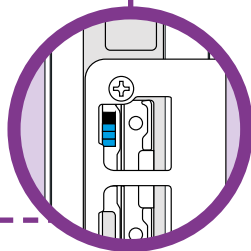

DOWN

When the Switch Latch is in the **DOWN** position, no key is required. The door can open or close freely, allowing you to gain entry to the property.

To adjust the Switch Latch

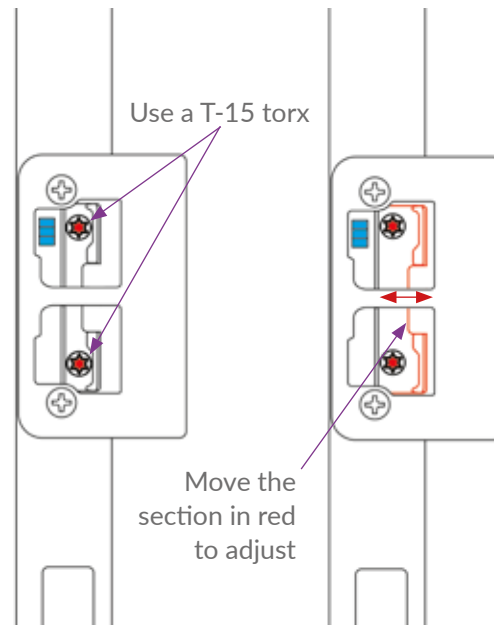



Rockdoor's Five Star Installation Guide

We have designed our installation instructions around 5 simple key checks which are **1 - Head Gap, 2 - Side Gap, 3 - Viewing Gap, 4 - Operation and 5 - Hinge Lock.** If you can tick off each of these checks, the Rockdoor will perform as expected.

1

HEAD GAP CHECK

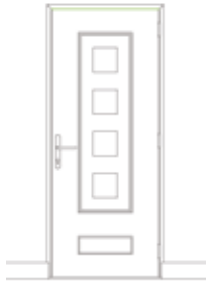

The head gap should be 4mm.



2

SIDE GAP CHECK

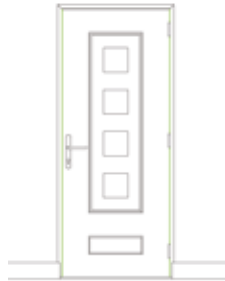

The side gaps should be 4mm.



3

VIEWING GAP CHECK



The viewing gap must be parallel.



4

OPERATION CHECK

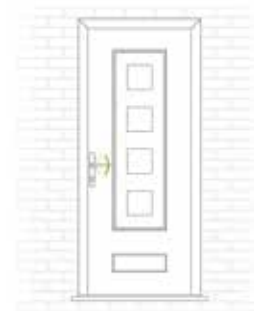

The door should open, close and lock smoothly.



5

HINGE LOCK CHECK

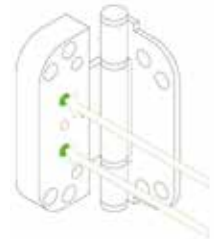

All 3 hinges should be locked tight.



For installation tolerances or should you encounter any problems, please refer to our Trouble Shooting Guide available from our customer service team or by visiting:

www.rockdoor.com/five-star-trouble-shooting

**ROCK
DOOR**



PROTECTING
HOMES SINCE

1997